



**BLUE  
CLEAN**®



**CATALOGO CLEANING  
DIVISION CATALOGUE**

**IDROPULTRICI LINEA HOME&GARDEN P 8**

<i>Home&amp;Garden line High pressure washers</i>	
<b>Applicazioni Applications</b>	P 11
<b>Pompe Pumps</b>	P 12
<b>SERIE SERIES 1</b>	P 14
<b>SERIE SERIES 3</b>	P 16
<b>SERIE SERIES DSS</b>	P 18
<b>SERIE SERIES DHS</b>	P 22
<b>SERIE SERIES DTS</b>	P 24
<b>SERIE SERIES DTS Wi-touch</b>	P 28
<b>SERIE SERIES 4</b>	P 30
<b>SERIE SERIES 5</b>	P 31
<b>SERIE SERIES BC250 DSS</b>	P 32
<b>Accessori Accessories</b>	P 40

**IDROPULTRICI LINEA PROFESSIONAL P 42**

<i>Professional line High pressure washers</i>	
<b>PRO COLD</b>	P 43
<b>Applicazioni Applications</b>	P 46
<b>Pompe Pumps</b>	P 49
<b>SERIE SERIES 5</b>	P 58
<b>SERIE SERIES DPS</b>	P 60
<b>SERIE SERIES 6</b>	P 63
<b>SERIE SERIES 7</b>	P 74
<b>SERIE SERIES 9</b>	P 76
<b>SERIE SERIES 10</b>	P 79
<b>SERIE SERIES 11</b>	P 85
<b>SERIE SERIES 14</b>	P 86
<b>Accessori Accessories</b>	P 98

**PRO HOT P 106**

<b>Applicazioni Applications</b>	P 108
<b>Pompe Pumps</b>	P 110
<b>SERIE SERIES 25</b>	P 114
<b>SERIE SERIES 35</b>	P 114
<b>SERIE SERIES 45</b>	P 114
<b>SERIE SERIES 56</b>	P 116
<b>SERIE SERIES 58</b>	P 117
<b>SERIE SERIES 66</b>	P 118
<b>SERIE SERIES 69</b>	P 119
<b>SERIE SERIES 78</b>	P 120
<b>SERIE SERIES 88</b>	P 121
<b>SERIE SERIES 13</b>	P 122
<b>Accessori Accessories</b>	P 124

**ASPIRATORI VACUUM CLEANERS P 130**

<b>Applicazioni Applications</b>	P 132
<b>SERIE SERIES 31</b>	P 134
<b>SERIE SERIES 32</b>	P 135
<b>SERIE SERIES 33</b>	P 136
<b>SERIE SERIES 36</b>	P 137
<b>SERIE SERIES 37</b>	P 138
<b>E12</b>	P 140
<b>M20</b>	P 141

**VACUUM CLEANERS PRO P 142**

<b>Applicazioni Applications</b>	P 144
<b>SERIE SERIES 41</b>	P 146
<b>SERIE SERIES 42</b>	P 147
<b>SERIE SERIES 43.44</b>	P 149
<b>SERIE SERIES 47</b>	P 153
<b>SERIE SERIES 48</b>	P 154
<b>SERIE SERIES 42L</b>	P 155
<b>SERIE SERIES 43L</b>	P 156
<b>SERIE SERIES 49</b>	P 157
<b>Accessori Accessories</b>	P 158

**POMPE WATER PUMPS P 168**

<b>Applicazioni Applications</b>	P 171
<b>SERIE SERIES ARGP 600P</b>	P 174
<b>SERIE SERIES ARGP 800X</b>	P 175
<b>SERIE SERIES ARGP 1100X</b>	P 176
<b>SERIE SERIES ARGP 600PB</b>	P 180
<b>SERIE SERIES ARGP 800XB</b>	P 181
<b>SERIE SERIES ARGP 1100XB</b>	P 183
<b>SERIE SERIES ARUP 250PC</b>	P 186
<b>SERIE SERIES ARUP 400PC</b>	P 187
<b>SERIE SERIES ARUP 750XC</b>	P 188
<b>SERIE SERIES ARUP 750PT</b>	P 191
<b>SERIE SERIES ARUP 1100XD</b>	P 225
<b>Accessori Accessories</b>	P 226

**MERCHANDISING P 196**

**LOGISTIC DATA P 202**





# HOME & GARDEN

Una gamma di prodotti studiati nei minimi dettagli per assicurare facilità di utilizzo ed estrema affidabilità nell'ambiente domestico. Idropultrici ideali per tutta la famiglia, versatili e leggere diventano lo strumento di pulizia ottimale per rimuovere lo sporco da vialetti, balconi, auto, biciclette e moto e diventano strumenti indispensabili per gli appassionati di giardinaggio. Perfette anche per rimuovere, senza fatica, il muschio e le incrostazioni del tempo dalle recinzioni o dagli arredi da esterno, per la pulizia del patio vicino a piscine e per gazebo e lettini solari. E' per questo che ARBC fa la differenza: ha la soluzione ideale per ogni tipo di esigenza.

*A range of products designed down to the tiniest detail to ensure ease of use and extreme reliability in the home.*

*Ideal high pressure washers for all the family: versatile and light weight, they are excellent for removing dirt from paths, balconies, cars, bicycles and motorbikes, and are an essential tool for gardening enthusiasts.*

*They are also perfect for effortlessly removing moss and deposits left by time from fences or outdoor furniture, and cleaning poolside patios, gazebos and sunbeds.*

*This is why ARBC makes a real difference: it has the right solution for every type of need.*





# Applicazioni ed indicatori di prestazioni Home & Garden

## Home & Garden performance Indicators & Applications

### BLUE CLEAN LEVEL

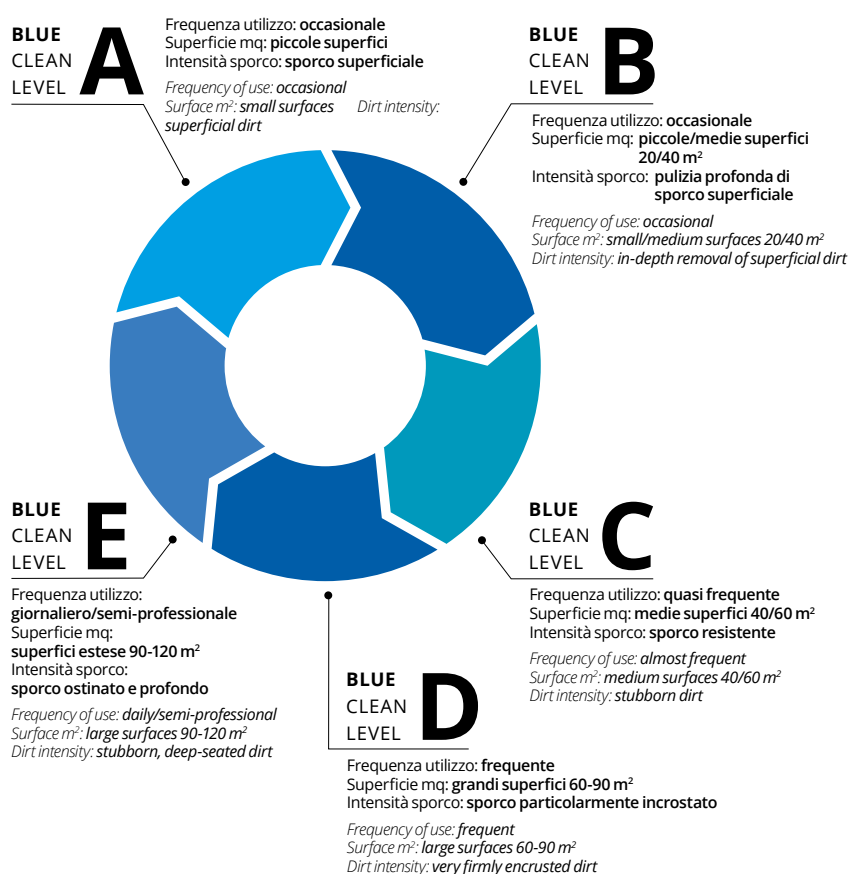

**BLUE CLEAN LEVEL** ti guida nella scelta del prodotto migliore, in base ad ogni esigenza di pulizia, affiancando ad ogni idropulitrice o aspiratore un'icona di livello lavaggio, insieme con le applicazioni. Ogni prodotto ha le sue caratteristiche tecniche ma anche estetiche-funzionali per soddisfare specifiche necessità del cliente, come la facilità d'uso, la compattezza, l'ergonomia, il peso, la rumorosità e la manovrabilità. Grazie al Blue Clean Level suggeriamo ad ogni cliente la combinazione migliore: è per questo che i prodotti ARBC fanno la differenza.

**BLUE CLEAN LEVEL** guides you in the choice of the best products for all cleaning needs, by placing a cleaning level icon next to every high pressure washer or vacuum cleaner, together with its applications. Every product has its own technical, stylistic and functional characteristics, to satisfy specific customer requirements, such as ease of use, compact size, labour-saving, weight, noise output and agility. With Blue Clean Level we direct every customer towards the ideal combination: this is why ARBC products make a real difference.

### BLUE CLEAN FACTOR



La combinazione ideale tra prestazioni tecniche e configurazione commerciale per poter risolvere al meglio le tue esigenze di pulizia. I prodotti che hanno il BLUE FACTOR sono i migliori, all'interno della loro categoria, per poter pulente, facilità d'utilizzo e prestazioni tecniche. Il mix perfetto per ogni tua esigenza di pulizia.

The ideal combination of technical features and commercial configuration, to deliver the best solution to your cleaning needs. Products with the BLUE FACTOR are best-in-class in cleaning power, ease of use and technical performances. The perfect mix for all your cleaning requirements.

# HOME & GARDEN APPLICATIONS



<b>cancellate</b> fencing	<b>panchine</b> benches	<b>giardino</b> garden	<b>biciclette</b> bicycles	<b>moto</b> motorcycle	<b>disinfestazione</b> pest control
<b>auto</b> cars	<b>camper</b> recreational vehicles RV's, campers	<b>barche</b> boats	<b>pavimenti</b> flooring, paving stones	<b>scale</b> stairs	<b>gardening</b> gardening
<b>piscine</b> pools	<b>utensili</b> tools	<b>casa</b> house	<b>muri</b> walls	<b>tetti</b> roofs	<b>sanificazione</b> sanitizing

Le idropulitrici della gamma Home & Garden sono la soluzione perfetta per la pulizia degli spazi domestici ed esterni: dimezzano i tempi di pulizia, rendendo il lavoro semplice e di facile esecuzione, grazie anche ad un'ampia selezione di accessori studiata per i diversi campi di applicazione.

Ne è un esempio il patio con serbatoio detergente incorporato, ideale per la pulizia di ampie superfici quali terrazze e bordi piscina, che ottiene risultati uniformi e brillanti alla prima passata!

Le potenti lance con getto rotopower assicurano invece il miglior risultato sull'arredo da esterno, che costantemente esposto alle intemperie è spesso aggredito da sporco ostinato, con un semplice gesto.

*Home & Garden range high pressure washers are the perfect solution for cleaning spaces inside and outside the home: washers halve cleaning times, making the whole process simple and easy - thanks also to a wide range of accessories designed for the various fields of use. One example is the patio version, with integral detergent tank, ideal for cleaning large areas such as patios and swimming pool surrounds, which provides gleaming, uniform results in a single pass! In another application, the powerful lances with rotopower jet at the appropriate pressure setting ensure the best results on outdoor furniture, which is constantly exposed to the weather and often accumulates stubborn dirt, with the greatest of ease.*

<b>1 Series</b>																			
117	●	●	●	●															
143	●	●	●	●	●					●									
<b>3 Series</b>																			
387	●	●	●	●	●				●	●	●		●						
397	●	●	●	●	●				●	●	●		●						
<b>DSS Series</b>																			
2.0 PE	●	●	●	●	●	●	●	●	●	●	●	●	●	●	●	●	●	●	●
3.0 PE	●	●	●	●	●	●	●	●	●	●	●	●	●	●	●	●	●	●	●
<b>DHS Series</b>																			
2.A	●	●	●	●	●				●	●	●		●				●	●	●
<b>DTS Series</b>																			
4.0TF	●	●	●	●	●	●	●	●	●	●	●	●	●	●	●	●	●	●	●
5.0TF	●	●	●	●	●	●	●	●	●	●	●	●	●	●	●	●	●	●	●
<b>DTS Wi-Touch Series</b>																			
4.1	●	●	●	●	●	●	●	●	●	●	●	●	●	●	●	●	●	●	●
<b>4 Series</b>																			
492						●	●	●	●	●	●	●	●	●	●	●	●	●	●
<b>5 Series</b>																			
587						●	●	●	●	●	●	●	●	●	●	●	●	●	●
<b>BC250 DSS</b>																			
	●	●		●	●	●	●												

# Pompe

## *Pumps*

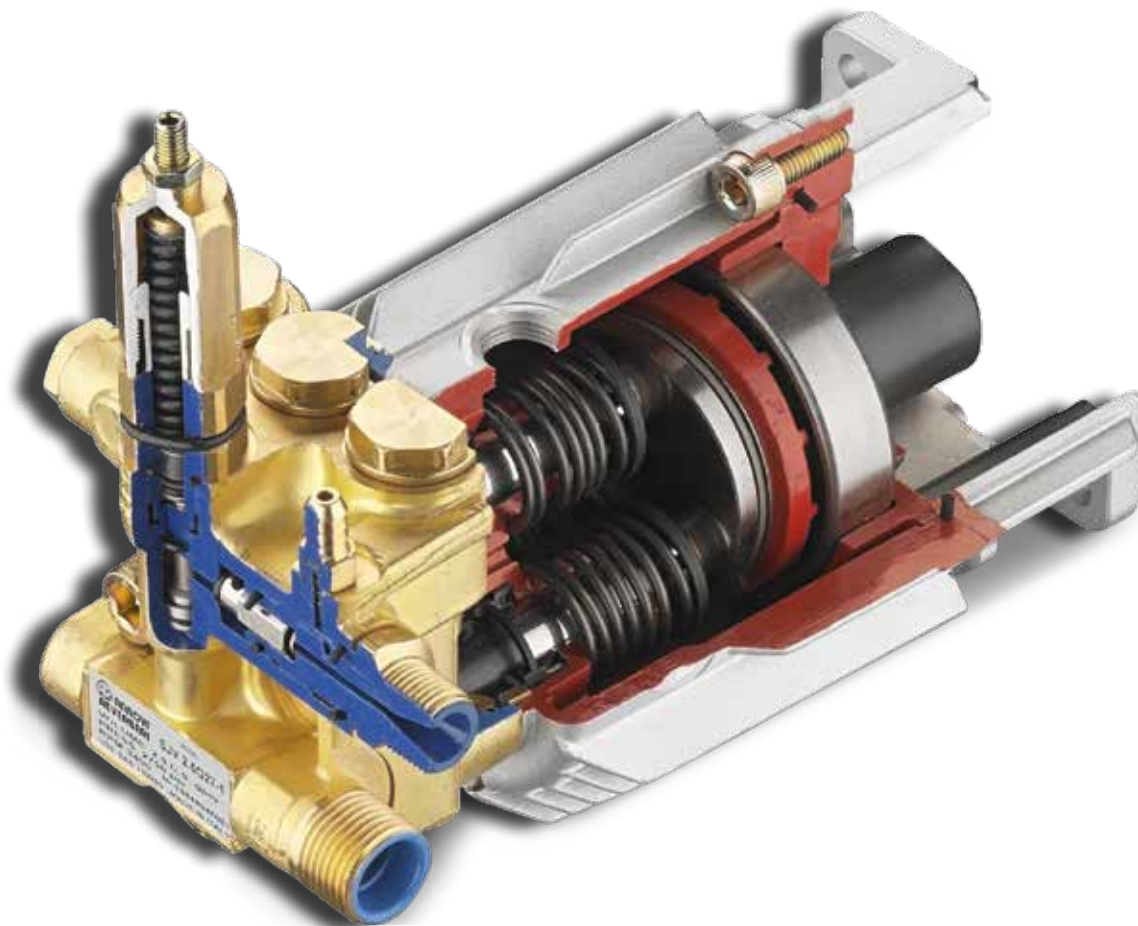

Pompa a piattello oscillante di dimensioni ridotte per utilizzo sia ad asse orizzontale che verticale.  
 Corpo pompa realizzato in lega d'alluminio per un'alta resistenza.  
 Il piattello oscillante è sempre realizzato in lega d'alluminio con un particolare trattamento antiusura. I componenti interni sono tutti di dimensioni maggiorate in grado così di garantire una buona affidabilità anche in condizioni di lavoro particolarmente gravoso.

*Compact wobble-plate pump for use both horizontal and vertical.  
 Aluminium alloy pump body for high strength. The wobble plate is also in aluminium alloy with a special wear-resistant coating. Internal components are all oversized, to guarantee excellent reliability even in particularly heavy-duty conditions.*



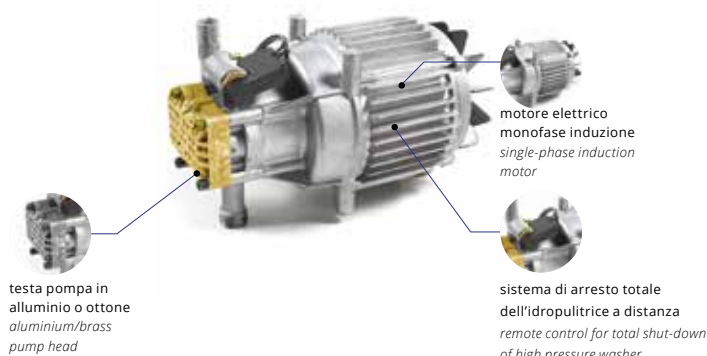

- Pompa a 3 pistoni assiali comandati dal piattello oscillante, testa alluminio
- Pistoni in acciaio inox temperato
- Valvola di sicurezza automatica che diminuisce la pressione residua, agevola l'azionamento della leva pistola e riduce l'affaticamento della mano
- Motore elettrico monofase con protezione termica
- Sistema di arresto totale dell'idropulitrice a distanza
- Aspirazione acqua da serbatoio con funzione autoadescente

- 3 Axial stainless steel pistons wobble-plate pump with aluminium head
- Tempered stainless steel pistons
- Automatic safety valve that decreases the residual pressure, facilitates the operation of the gun lever and reduces hand fatigue
- Single-phase motor with thermal protector
- Remote control for total shut-down of high pressure washer
- Inlet water suction from tank by self priming function

- Pompa a 3 pistoni assiali comandati dal piattello oscillante
- Pistoni in acciaio inox temperato
- Testa pompa in alluminio (Mod.492)
- Testa pompa in ottone (Mod.587)
- Valvola di sicurezza automatica che diminuisce la pressione residua, agevola l'azionamento della leva pistola e riduce l'affaticamento della mano (mod. 492.587)
- Motore elettrico monofase a induzione con protezione termica
- Sistema di arresto totale dell'idropultrice a distanza
- Aspirazione acqua da serbatoio con funzione autoadescente

- 3 Axial stainless steel pistons wobble-plate pump
- Tempered stainless steel pistons
- Aluminium pump head (Mod.492)
- Brass pump head (Mod.587)
- Automatic safety valve that decreases the residual pressure, facilitates the operation of the gun lever and reduces hand fatigue (mod. 492.587)
- Single-phase induction motor with thermal protector
- Remote control for total shut-down of high pressure washer
- Inlet water suction from tank by self priming function



## POMPE / PUMPS

		1300 WATT	1500 WATT	1900 WATT	2200 WATT	2500 WATT	2500 WATT	2700 WATT	2100 WATT	2500 WATT
SERIE / SERIES	117	●								
	143		●							
	387			●						
	397				●					
	2.0				●					
	3.0					●				
	2.A DHS				●					
	4.0 TF						●			
	5.0 TF							●		
	4.1 WiTouch						●			
	492								●	
587									●	



# 1 Series 117

IDROPULTRICI ALTA PRESSIONE  
high pressure washers

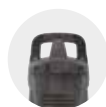

porta accessori  
built-in accessories  
holder



filtro ingresso acqua  
ispezionabile  
inspectable water  
intake filter



portatile  
portable



dispositivo click -fast  
click-fast connection drive

## Caratteristiche Generali

- Pompa a 3 pistoni assiali comandati dal piattello oscillante, testa in alluminio
- Pistoni in acciaio inox temperato
- Valvola di sicurezza automatica con azzeramento della pressione nella testa pompa
- Protezione termica del motore
- Serbatoio detergente
- Funzione autoadescante
- Tubo alta pressione (3 m)

## General Features

- 3 Axial stainless steel pistons wobble-plate pump with aluminium head
- Tempered stainless steel pistons
- Automatic by-pass valve with pump head pressure discharge
- Motor thermal protector
- Detergent tank
- Self-priming function
- High pressure hose (3 m)

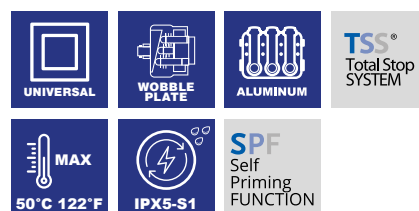

MOD	COD	MAX		MAX					KG NET
		bar	psi	l/h	gph	kW	Hz	V	kg
117	13689	110	1600	390	103	1,3	50-60	220-240~	5,6

## Accessori standard Standard accessories



41559

41563

41564



46348  
(3 m)

41570



### Caratteristiche Generali

- Carrello a 2 ruote completo di manico
- Pompa a 3 pistoni assiali comandati dal piattello oscillante, testa in alluminio
- Pistoni in acciaio inox temperato
- Valvola di sicurezza automatica con azzeramento della pressione nella testa pompa
- Protezione termica del motore
- Ugello rotante
- Serbatoio detergente
- Funzione autoadescante
- Tubo alta pressione (5 m)

### General Features

- Two-wheel trolley with handle
- 3 Axial stainless steel pistons wobble-plate pump with aluminium head
- Tempered stainless steel pistons
- Automatic by-pass valve with pump head pressure discharge
- Motor thermal protector
- Rotay nozzle
- Detergent tank
- Self-priming function
- High pressure hose (5 m)

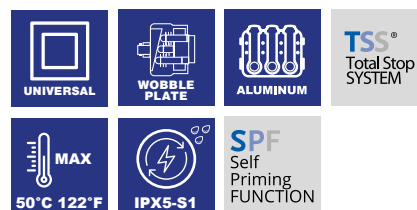

MOD	COD	MAX		MAX					KG NET
		bar	psi	l/h	gph	kW	Hz	V	kg
143	13690	120	1740	390	103	1,5	50-60	220-240~	5,9

### Accessori standard

Standard accessories





# 3 Series 387

IDROPULTRICI ALTA PRESSIONE  
high pressure washers



TRADE SELECTION



## Caratteristiche Generali

- Carrello a 2 ruote completo di manico
- Pompa a 3 pistoni assiali comandati dal piattello oscillante, testa alluminio
- Pistoni in acciaio inox temperato
- Valvola di sicurezza automatica con azzeramento della pressione nella testa pompa
- Protezione termica del motore
- Tubo alta flessibilità (6 m)
- Ugello rotante
- Serbatoio detergente
- Funzione autoadescante

## General Features

- Two-wheel trolley with handle
- 3 Axial stainless steel pistons wobble-plate pump with aluminium head
- Tempered stainless steel pistons
- Automatic by-pass valve with pump head pressure discharge
- Motor thermal protector
- Super flexible hose (6 m)
- Rotary nozzle
- Detergent tank
- Self-priming function

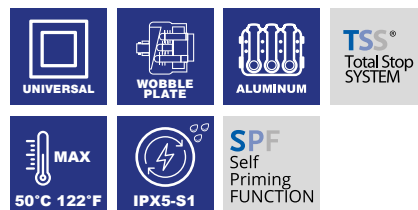

MOD	COD	MAX		MAX					KG NET
		bar	psi	l/h	gph	kW	Hz	V	kg
387	15458	150	2175	420	110	1,9	50-60	220-240~	7



## Accessori standard Standard accessories



46328

46332

46541  
(6 m)



47339



41565



46540



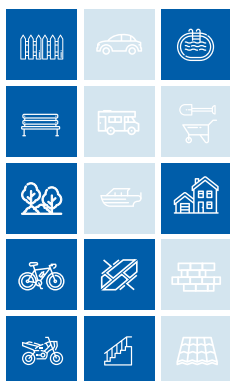

**TRADE SELECTION**

### Caratteristiche Generali

- Carrello a 2 ruote completo di manico ed avvolgitubo
- Pompa a 3 pistoni assiali comandati dal piattello oscillante, testa in alluminio
- Pistoni in acciaio inox temperato
- Valvola di sicurezza automatica con azzeramento della pressione nella testa pompa
- Protezione termica del motore
- Tubo alta flessibilità (6 m)
- Ugello rotante
- Serbatoio detergente
- Funzione autoadescante

### General Features

- Two-wheel trolley with handle and hose reel
- 3 Axial stainless steel pistons wobble-plate pump with aluminium head
- Tempered stainless steel pistons
- Automatic by-pass valve with pump head pressure discharge
- Motor thermal protector
- Super flexible hose (6 m)
- Rotary nozzle
- Detergent tank
- Self-priming function

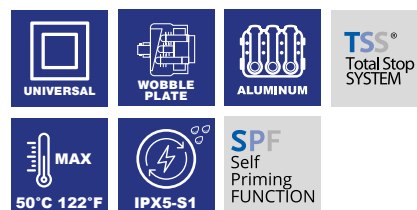

MOD	COD	MAX		MAX		V			KG NET
		bar	psi	l/h	gph	kW	Hz	V	kg
397	15459	160	2320	460	121	2,2	50-60	220-240~	7,6

### Accessori standard Standard accessories



# DUAL SPEED SYSTEM

## Sistema a doppia velocità.

Tramite il POWER SWITCH è possibile selezionare le modalità **ECO SPEED WASHING** e **MAX SPEED WASHING** e modulare il livello di performance dell'idropulitrice adeguandolo ad esigenze di pulizia più leggera, con un notevole risparmio di acqua e di energia (fino al 30%), o più intense in funzione del lavoro da svolgere.

*Using the POWER SWITCH it is possible to select the **ECO SPEED WASHING** and **MAX SPEED WASHING** modes, to modulate the performance level of the pressure washer, adapting it to lighter cleaning needs, with a considerable saving of water and energy (up to 30%), or more intense depending on the work to be done.*

# 30% ENERGY SAVING



## ECO SPEED

### 30% ENERGY SAVING

Attivando la modalità **ECO SPEED** puoi dedicarti alla pulizia di sporco non aggressivo su superfici esterne in legno, biciclette, mobili da giardino in legno, tessuti esterni, con un **consumo energetico ottimizzato** e un miglior compromesso tra efficacia del lavaggio/consumi.

*By activating **ECO SPEED** mode you can dedicate yourself to cleaning non-aggressive dirt on external wooden surfaces, bicycles, wooden garden furniture, external fabrics, with **optimized energy consumption** and a better compromise between washing / consumption effectiveness.*

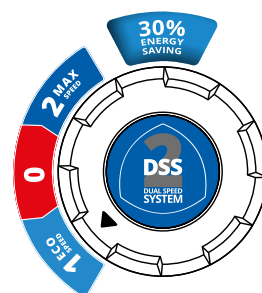

## MAX SPEED

### FULL PERFORMANCE

Attivando la modalità **MAX SPEED** puoi dedicarti invece alla pulizia di sporco aggressivo su pietra, cemento e mattoni, ringhiere e cancelli in metallo, attrezzi da lavoro e da giardinaggio, automezzi con un **consumo energetico standard**.

*By activating **MAX SPEED** mode you can dedicate yourself to cleaning aggressive dirt on stone, concrete and bricks, metal railings and gates, work and gardening tools, vehicles) with **standard energy consumption**.*

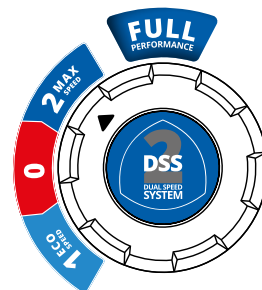



avvolgitubo statico con tubo alta flessibilità 6 m  
static hose reel with super flexible hose 6 m



schiumogeno alta pressione  
high pressure foam lance



battistrada in gomma  
rubber wheels



selettore rotativo a 3 posizioni  
off/Eco Speed/Full Speed  
3 positions rotative switch  
off/Eco Speed/Full Speed



dispositivo click -fast  
click-fast connection drive

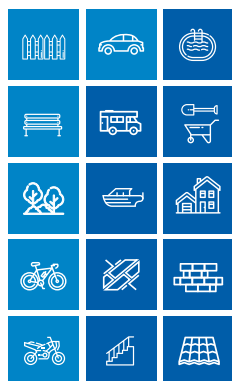

### Caratteristiche Generali

- Manico con avvolgitubo statico per
- Pompa a 3 pistoni assiali comandati dal piattello oscillante, testa in alluminio
- Pistoni in acciaio inox temperato
- Valvola di sicurezza automatica con azzeramento della pressione nella testa pompa
- Motore universale a due velocità con protezione termica
- Ugello rotante
- Lava superfici Ø250 mm
- Funzione autoadescante
- Tubo alta flessibilità (6 m)

### General Features

- Two-wheel trolley with handle and static hose reel
- 3 Axial stainless steel pistons wobble-plate pumps
- Tempered stainless steel pistons
- Automatic by-pass valve with pump head pressure discharge
- Dual speed single-phase universal motor with thermal protector
- Rotary nozzle
- Surface cleaner Ø250 mm
- Self-priming function
- Super flexible hose (6 m)

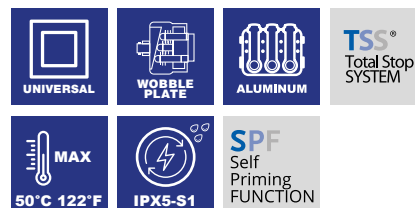

MOD	COD								
		MAX	MAX		NET				
		bar	psi	l/h	gph	kW	Hz	V	kg
2.0 PE	14986	160	2300	460	122	2,2	50-60	220-240~	10,3

### Accessori standard Standard accessories



46328

46332

46541  
(6 m)



46572



46356



41565



46327





# DSS Series 3.0 PE

IDROPULTRICI ALTA PRESSIONE  
high pressure washers



TRADE SELECTION

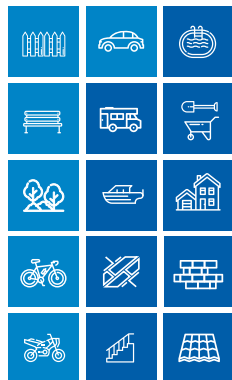

avvolgitubo statico con tubo alta flessibilità 6 m  
static hose reel with super flexible hose 6 m



schiumogeno alta pressione  
high pressure foam lance



battistrada in gomma  
rubber wheels



selettore rotativo a 3 posizioni  
off/Eco Speed/Full Speed  
3 positions rotative switch  
off/Eco Speed/Full Speed



dispositivo click-fast  
click-fast connection drive



## Caratteristiche Generali

- Manico con avvolgitubo statico
- Pompa a 3 pistoni assiali comandati dal piattello oscillante, testa in alluminio
- Pistoni in acciaio inox temperato
- Valvola di sicurezza automatica con azzeramento della pressione nella testa pompa
- Motore universale a due velocità con protezione termica
- Ugello rotante
- Lava superfici Ø250 mm
- Funzione autoadescante
- Tubo alta flessibilità (6 m)

## General Features

- Two-wheel trolley with handle and static hose reel
- 3 Axial stainless steel pistons wobble-plate pumps
- Tempered stainless steel pistons
- Automatic by-pass valve with pump head pressure discharge
- Dual speed single-phase universal motor with thermal protector
- Rotary nozzle
- Surface cleaner Ø250 mm
- Self-priming function
- Super flexible hose (6 m)

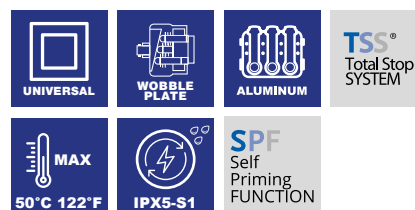

MOD	COD	MAX	MAX		NET				
		bar	psi	l/h	gph	kW	Hz	V	kg
3.0 PE	14988	180	2600	500	132	2,5	50-60	220-240~	10,5



## Accessori standard Standard accessories



46328

46332  
(42 cm)

46541  
(6 m)



46572

46356

41565

46540





# DUALHYG SYSTEM

## Doppia azione, Doppia efficacia



Attivando **I Spraying Mode** si potrà utilizzare la lancia per nebulizzazione prodotti che andranno preventivamente inseriti nel serbatoio. Particolarmente adatta per igienizzare, sanificare, e prelavare superfici e forniture esterne. Ideale per disinfezione zanzare e applicazioni gardening.

*Activate **I Spraying Mode** to sanitize, pre-wash or to do pest control according to the product previously insert into the tank. The perfect model for sanitizing and pre-washing external surfaces and garten furnitures, for doing mosquito control and for garden applications such as spraying.*

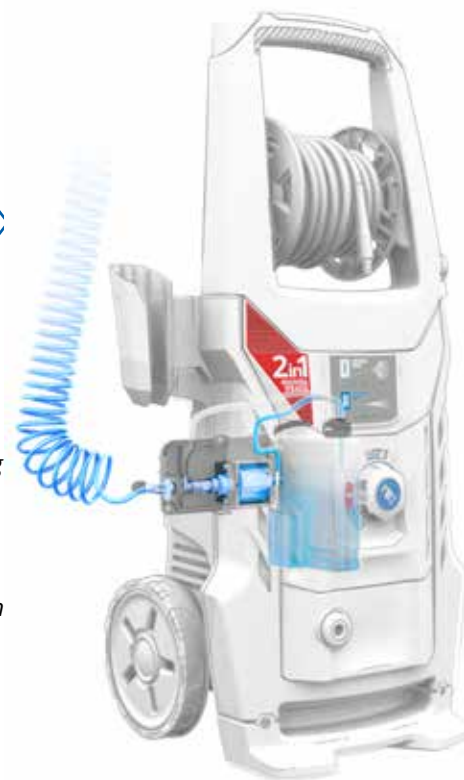

Attivando **II Washing Mode** si potrà utilizzare la lancia per lavare e risciacquare le superfici preventivamente trattate. Adatta per cancellate, muri e pavimentazioni nonchè bici, moto ed automobili.

*Activate **II Washing Mode** to use the lance to wash, clean and rinse the previously treated surfaces. With its powerful motorpump it's suitable to remove dirt from fences, walls, bicycles, motorcycles and cars.*

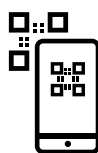
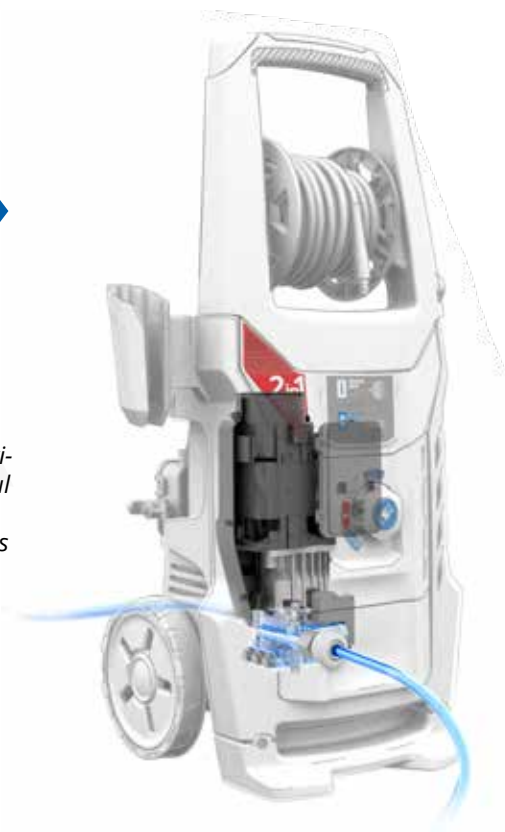

# DHS Series 2.A

IDROPULTRICI ALTA PRESSIONE  
high pressure washers



lancia per nebulizzazione  
con tubo 6 metri  
spraying lance with  
6 meters hose

avvolgitubo statico con tubo  
alta flessibilità 6 m  
static hose reel with super  
flexible hose 6 m

battistrada in gomma  
rubber wheels

selettore rotativo a 3 posizioni  
off/spraying mode/washing mode  
3 positions rotative switch  
off/spraying mode/washing mode

serbatoio integrato  
built-in tank

dispositivo click -fast  
click-fast connection  
drive



## Caratteristiche Generali

- Manico con avvolgitubo statico
- Lancia Washing
- Lancia Spraying
- Pompa a 3 pistoni assiali comandati dal piattello oscillante, testa in alluminio
- Pistoni in acciaio inox temperato
- Valvola di sicurezza automatica con azzeramento della pressione nella testa pompa
- Motore universale con protezioni termiche ed elettropompa a vibrazione monofase
- Ugello rotante
- Funzione autoadescante
- Tubo alta flessibilità (6 m)

## General Features

- Two-wheel trolley with handle and static hose reel
- Washing lance
- Spraying lance
- 3 Axial stainless steel pistons wobble-plate pumps
- Tempered stainless steel pistons
- Automatic by-pass valve with pump head pressure discharge
- Universal motor and electric single-phase vibrating pump.
- Rotary nozzle
- Self-priming function
- Super flexible hose (6 m)



MOD	COD									
			bar	psi	l/h	gph	kW	Hz	V	kg
2.A	15153	SPRAYING MODE	4	58	0,3	0,08	0,035	50	220-240~	10,55
		WASHING MODE	160	2320	460	122	2,2	50	220-240~	

## Accessori standard Standard accessories



46328      46332 (42 cm)      46541 (6 m)



46844      46845      46846      41565      46327





# DUALTECH SYSTEM

## Prestazioni migliori e risparmio di tempo.

*Improve performance. Save time.*

**1 POWER UNIT**

**ECO SOFT CLEANING**



Attiva **1 POWER UNIT** per un livello di lavaggio leggero particolarmente indicato per la pulizia di biciclette, moto e auto e adatto anche a staccionate, mobili da giardino e tende da sole.

*Activate **1 POWER UNIT** when you need to remove light dirt from bicycles, motorcycles, cars or you want fences, outdoor furniture and sun shades to seem like new.*

**2 POWER UNITS**

**FAST CLEANING**



Sfrutta la sinergia di **2 POWER UNITS** insieme quando devi eliminare macchie e sporco ostinato da pavimentazione di pietra o cemento, rivestimenti e muri di mattoni, attrezzature da costruzione.

*Exploit the synergy of **2 POWER UNITS** together when you need to get rid of the toughest dirt and stains from stone and cement flooring, brick walls and sidings, roofs or construction applications.*



**+50% WPP**

**Maggiore portata per una maggiore potenza prestazionale.**

**Stronger flow rate for a stronger washing power performance.**

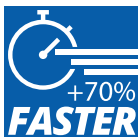

**+70% FASTER**

**TWIN NOZZLE**

**2X EFFECTIVE**



**Getto doppio, tempi dimezzati con l'esclusivo accessorio Twin Nozzle.**

**Double water jet, halved cleaning time with Twin Nozzle.**

Twin Flow si presenta equipaggiata con l'imperdibile accessorio, incluso nella confezione, utile per incrementare la performance di pulizia di grandi superfici risparmiando tempo e fatica. È particolarmente indicato per il lavaggio di muri in cemento o mattoni, pavimentazioni e piscine.

*Twin Flow features the ultimate must-have lance accessory, included inside the packaging, that will boost wide surfaces cleaning performance, saving your time and effort. It is perfect to wash concrete or brick walls, floorings, pools in a very efficient way.*

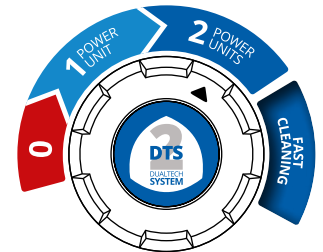
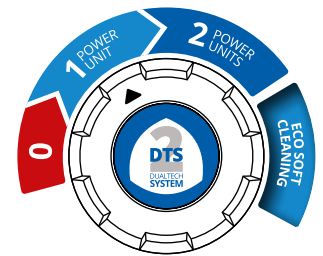



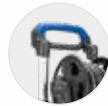

manico telescopico con avvolgitubo statico  
telescopic handle with static hose reel

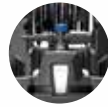

schiumogeno alta pressione  
high pressure foam lance



porta accessori integrato  
built-in accessory holders

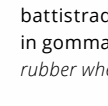

battistrada in gomma  
rubber wheels



tubo alta flessibilità 8m  
super flexible hose 8m



selettore rotativo a 3 posizioni  
off/Eco Soft Cleaning/Fast Cleaning  
3 positions rotative switch  
off/Eco Soft Cleaning/Fast Cleaning



filtro ingresso acqua ispezionabile  
inspectable water intake filter



Blue Clean Factor

## Caratteristiche Generali

- Manico telescopico con avvolgitubo statico
- 2 Pompe a 3 pistoni assiali comandati dal piattello oscillante, testa in alluminio
- Pistoni in acciaio inox temperato
- Valvola di sicurezza automatica con azzeramento della pressione nella testa pompa
- Doppio motore universale con protezione termica
- Sistema twin nozzle con doppio ugello rotante
- Funzione autoadescante
- Tubo alta flessibilità (8 m)

## General Features

- Two-wheel trolley with telescopic handle and static hose reel
- Two 3 Axial stainless steel pistons wobble-plate pumps
- Tempered stainless steel pistons
- Automatic by-pass valve with pump head pressure discharge
- Twin single-phase universal motor with thermal protector
- Twin nozzle system with double rotary nozzle
- Self-priming function
- Super flexible hose (8 m)

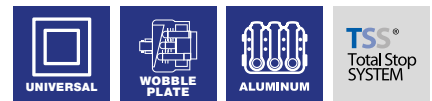

MOD	COD	MAX	MAX						
		bar	psi	l/h	gph	kW	Hz	V	kg
4.0	14792	150	2200	810	214	2,5	50-60	220-230~	14



**TWIN NOZZLE**

## Accessori standard Standard accessories



46328

46332  
(42 cm)

46337



46335  
(8 m)

46329  
(x2)

46330

46344



# DTS Series 5.0 TWIN FLOW

IDROPULTRICI ALTA PRESSIONE  
high pressure washer



TRADE SELECTION

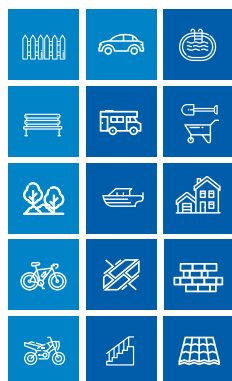

manico telescopico  
telescopic handle



schiumogeno  
alta pressione  
high pressure  
foam lance



porta accessori  
integrato  
built-in  
accessory holders



battistrada  
in gomma  
rubber wheels



avvolgitubo in pressione con tubo  
alta flessibilità 8m  
in-pressure hose reel with super flexible  
hose 8m



selettore rotativo a 3 posizioni  
off/Eco Soft Cleaning/Fast Cleaning  
3 positions rotative switch  
off/Eco Soft Cleaning/Fast Cleaning



filtro ingresso acqua  
ispezionabile  
inspectable water intake filter



## Caratteristiche Generali

- Manico telescopico con avvolgitubo in pressione
- 2 Pompe a 3 pistoni assiali comandati dal piattello oscillante, testa in alluminio
- Pistoni in acciaio inox temperato
- Valvola di sicurezza automatica con azzeramento della pressione nella testa pompa
- Doppio motore universale con protezione termica
- Sistema twin nozzle con doppio ugello rotante
- Ugello multi funzione 5 in 1
- Funzione autoadescante
- Tubo alta flessibilità (8 m)

## General Features

- Two-wheel trolley with telescopic handle and in-pressure hose reel
- Two 3 Axial stainless steel pistons wobble-plate pumps
- Tempered stainless steel pistons
- Automatic by-pass valve with pump head pressure discharge
- Twin single-phase universal motor with thermal protector
- Twin nozzle system with double rotary nozzle
- Multifunction 5 in 1 nozzle
- Self-priming function
- Super flexible hose (8 m)



MOD	COD	MAX	MAX						NET
		bar	psi	l/h	gph	kW	Hz	V	kg
5.0	14793	160	2300	850	225	2,7	50-60	220-230~	14,6



## TWIN NOZZLE

## Accessori standard Standard accessories



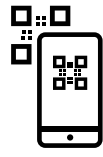

# DUALTECH SYSTEM Wi-TOUCH

Per attivare la modalità WI-TOUCH è sufficiente impostare il selettore di controllo sulla posizione 1.

Premendo in seguito la leva cambio modalità si controlla il passaggio tra modalità eco soft claning e fast cleaning e viceversa, in base alle proprie necessità.

**To activate the WI-TOUCH mode, simply set the control selector to position 1.**

*Then, by pressing the power change lever, you can switch between eco soft cleaning and fast cleaning modes and vice versa, according to your needs.*



power change  
LED indicator  
*indicatore LED  
di cambio modalità*



power change trigger  
*leva cambio modalità*



La modalità **ECO CLEANING** attiva un lavaggio leggero che permette di evitare inutili sprechi di acqua ed energia, particolarmente indicato per pulire veicoli, staccionate, mobili da giardino, tende da sole e superfici delicate.

*The **ECO CLEANING** mode activates a light wash that allows you to avoid unnecessary waste of water and energy, particularly suitable for cleaning vehicles, fences, garden furniture, awnings and delicate surfaces.*

La modalità **FAST CLEANING** offre un miglioramento delle performance del 50% grazie all'incremento della intensità e dell'ampiezza del getto pulente offrendo una pulizia eccellente anche sullo sporco più ostinato. Consigliata per lavare velocemente le superfici più estese, per pulire in altezza e per eliminare macchie e sporco profondo da pavimentazioni di pietra o cemento, rivestimenti e muri di mattoni, attrezzature da costruzione.

*The **FAST CLEANING** mode offers a 50% performance improvement thanks to an increase in the intensity and width of the cleaning jet, offering excellent cleaning even on the most stubborn dirt. Recommended for quickly washing larger surfaces, for cleaning at height and for removing stains and deep dirt from stone or concrete floors, brick claddings and walls, construction equipment.*





# DTS Series 4.1 Wi-TOUCH

IDROPULTRICI ALTA PRESSIONE  
high pressure washers

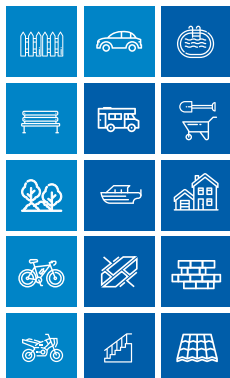

pistola Wi-TOUCH con prolunga  
*Wi-TOUCH trigger gun with gun extension*

schiumogeno alta pressione  
*high pressure foam lance*

porta accessori integrato  
*built-in accessory holders*

Twin Nozzle

manico telescopico con ganci per appoggio pistola  
*telescopic handle with gun parking hooks*

tubo alta flessibilità 8m  
*super flexible hose 8m*

selettore ergonomico di controllo Wi-TOUCH mode  
*ergonomic Wi-TOUCH mode control switch*

filtro ingresso acqua ispezionabile  
*inspectable water intake filter*



## Caratteristiche Generali

- Pistola Wi-TOUCH con controllo remoto
- Manico telescopico con avvolgitubo statico per tubo AP
- 2 pompe a 3 pistoni assiali comandati dal piattello oscillante, testa in alluminio
- Pistoni in acciaio inox temperato
- Valvola di sicurezza automatica che diminuisce la pressione residua, agevola l'azionamento della leva pistola e riduce l'affaticamento della mano
- Doppio motore universale con protezione termica
- Sistema twin nozzle con doppio ugello rotante
- Funzione autoadescante

## General Features

- *Wi-TOUCH trigger gun with remote control*
- *Two-wheel trolley with telescopic handle and static hose reel*
- *Two 3 axial stainless steel pistons wobble-plate pumps*
- *Tempered stainless steel pistons*
- *Automatic safety valve that decreases the residual pressure, facilitates the operation of the gun lever and reduces hand fatigue*
- *Twin single-phase universal motor with thermal protector*
- *Twin nozzle system with double rotary nozzle*
- *Self-priming function*

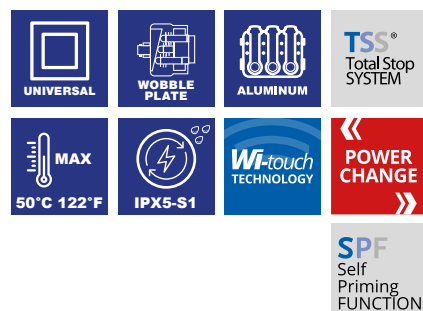

MOD	COD	MAX	MAX							KG NET
		bar	psi	l/h	gph	kW	rpm	Hz	V	kg
4.1	15180	150	2175	810	214	2,5	3400	50	220-240~	14,7



**TWIN NOZZLE**

## Accessori standard Standard accessories







# 4 Series 492

IDROPULTRICI ALTA PRESSIONE  
high pressure washers



## Caratteristiche Generali

- Carrello a 2 ruote completo di manico
- Pompa a 3 pistoni assiali comandati dal piattello oscillante, testa in alluminio
- Pistoni in acciaio inox temperato
- Valvola di sicurezza automatica con azzeramento della pressione nella testa pompa
- Motore ad induzione con protezione
- Aspirazione detergente diretta con serbatoio incorporato
- Capacità del serbatoio detergente 1,4 l
- Tubo rinforzato con treccia in acciaio (8 m)
- Funzione autoadescente

## General Features

- Two-wheel trolley with handle
- 3 Axial stainless steel pistons wobble-plate pump with aluminium head
- Tempered stainless steel pistons
- Automatic by-pass valve with pump head pressure discharge
- Induction motor with thermal protection
- Built-in detergent tank for direct suction
- Detergent tank capacity 1.4 l
- Steel braided hose (8 m)
- Self-priming function

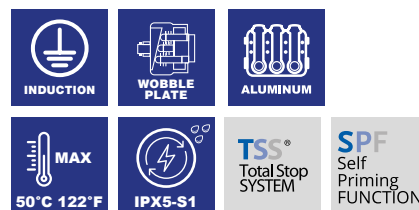

MOD	COD	MAX		MAX					KG NET
		bar	psi	l/h	gph	kW	Hz	V	kg
492	15594	150	2175	450	119	2,1	50	220-240~	21,1



## Accessori standard Standard accessories



4381913

47685

46578



43987  
(8 m)



### Caratteristiche Generali

- Carrello a 2 ruote completo di manico
- Pompa a 3 pistoni assiali comandati dal piattello oscillante, testa in alluminio
- Pistoni in acciaio inox temperato
- Valvola di sicurezza automatica con azzeramento della pressione nella testa pompa
- Motore ad induzione con protezione
- Aspirazione detergente diretta con serbatoio incorporato
- Capacità del serbatoio detergente 1,4 l
- Tubo rinforzato con treccia in acciaio (8 m)
- Funzione autoadescante

### General Features

- Two-wheel trolley with handle
- 3 Axial stainless steel pistons wobble-plate pump with aluminium head
- Tempered stainless steel pistons
- Automatic by-pass valve with pump head pressure discharge
- Induction motor with thermal protection
- Built-in detergent tank for direct suction
- Detergent tank capacity 1.4 l
- Steel braided hose (8 m)
- Self-priming function

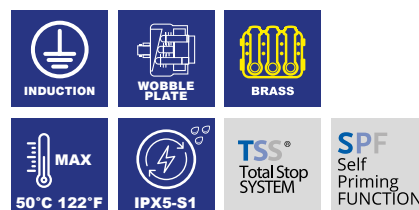

MOD	COD	MAX	MAX						KG NET
		bar	psi	l/h	gph	kW	Hz	V	kg
587	15595	160	2320	460	121	2,5	50	220-240~	22,3

### Accessori standard Standard accessories



4381913

47686

46578



43987  
(8 m)



**NEW**

# BATTERY WATER CLEANER

Idropistola portatile a batteria dotata del sistema tecnologico DSS Annovi Reverberi che consente di modulare le performance passando dalla modalità ECO SPEED e quella MAX SPEED in base all'esigenza di lavaggio, premendo l'apposito pulsante. Portatile, compatta, versatile e indipendente da rete idrica ed elettrica. Ideale per molteplici situazioni nell'esterno casa e outdoor living.

*The Battery Water Cleaner is equipped with the DSS technological system by Annovi Reverberi that allows to modulate the performance choosing among the ECO SPEED mode and the MAX SPEED mode through the appropriate button any time needed according to the surface. Independent of the water supply, portable, compact and versatile. Perfect for many outdoor situations and more.*

**Batteria al litio ricaricabile da 18V inclusa.**

*18V Rechargeable lithium battery included.*



**ECO SPEED**

**50% ENERGY SAVING**



**DSS**

**DUAL SPEED SYSTEM**

**MAX SPEED**

**FULL PERFORMANCE**



**18V**

**0°/ 20°/ 60° +  
ROTARY JET NOZZLE**

Quattro funzionalità  
in un unico accessorio.  
*One nozzle,  
multiple uses.*



**4in1  
NOZZLE**



### Caratteristiche Generali

- Idropistola a batteria (18V)
- Batteria ricaricabile al litio
- Sistema tecnologico DSS integrato
- Selettore modalità ECO/MAX SPEED
- Motopompa anti-vibrazione e silenziosa
- Kit schiumogeno
- Kit autoadescamento (4 m)

### General Features

- Battery Water Cleaner
- Rechargeable lithium battery
- Double Speed System
- ECO/MAX SPEED selector
- Super Silent anti-vibration motor-pump
- Foam lance bottle
- Self-priming kit (4 m)

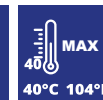

MOD	COD	DSS	MAX	MAX							
			bar	psi	l/h	gph	V	Ah	battery run time	motor type	kg
BC250 DSS	15389	MAX SPEED	24	350	175	46.2	18	2,5	11 min*	DC 250 W	1,8

### Accessori standard Standard accessories



\* 21 min. ECO SPEED MODE

# **ACCESSORI & DETERGENTI**

*Accessories & detergents*







## CARATTERISTICHE GENERALI

Innovativo e pratico accessorio multifunzione per idropulitrici ad alta pressione che permette, grazie ad un semplice click, il passaggio dall'azione di lavaggio (**modalità CLEAN**) a quella di risciacquo e asportazione (**modalità SWEEP**). Grazie ai 3 ugelli, la **superficie pulente aumenta del 30%** consentendo un risparmio di tempo e di energia.

## GENERAL FEATURES

*Innovative and practical multifunctional accessory for high pressure washers which allows, thanks to a simple click, the switch from the washing action (**CLEAN mode**) to the rinsing and sweeping action (**SWEEP mode**). Thanks to the 3 nozzles, **the cleaning surface increases by 30%**, saving time and energy.*



**NEW**

serbatoio detergente trasparente con regolazione dosaggio\*  
*transparent detergent tank with dosage adjustment\**

ruote  
*wheels*

leva cambio posizione  
*position change lever*



3 ugelli  
*3 nozzles*

setole ad alta efficacia pulente  
*highly effective cleaning bristles*



## APPLICAZIONI - APPLICATIONS



pavimenti  
flooring,  
paving  
stones



scale  
stairs



casa  
house



piscine  
pools

## CLEAN MODE

Nella modalità **CLEAN** l'azione meccanica combinata del getto ad alta pressione a tre ugelli e delle setole consente la rimozione e l'asportazione di ogni tipo di sporco dalla superficie trattata.

*The CLEAN mode combines the mechanical action of three-nozzle high pressure jet with the bristles, allowing you to remove any type of dirt from treated surfaces*

1

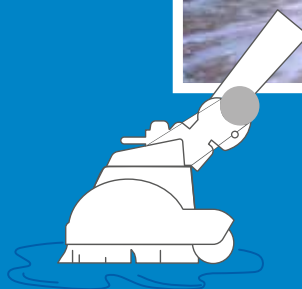

2

## SWEEP MODE

Grazie alla sua posizione ergonomica la modalità **SWEEP** consente di allontanare lo sporco rimosso e i residui di detergente lasciando la superficie perfettamente pulita.

*Thanks to its ergonomic position, the SWEEP mode allows you to remove the dirt previously detached and detergent residues, leaving the surface perfectly cleaned.*

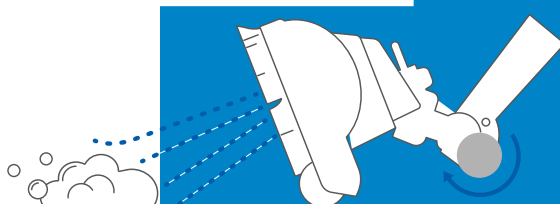

**+30%** di superficie pulita\*  
of cleaned area\*



\*rispetto ad un normale patio cleaner  
\*compared to a normal patio cleaner



# Detergenti. *Detergent*



## AUTO&BARCHE *cars and boats*

Detergente pronto all'uso.  
Ideale per parabrezza e superfici metalliche delicate.  
Rimuove lo sporco oleoso senza lasciare aloni.  
Piacevole fragranza alla mente piperita.  
Formulazione esente da EDTA e NTA e conservanti privi di formaldeide ed alogeni.

*Ready-to-use cleaner.  
Ideal for windscreens and delicate metal surfaces. Removes oily dirt without leaving smears.  
Pleasant peppermint scent.  
Formula free from EDTA and NTA and preservatives without formaldehyde or halogens.*

Cod. 41872



## PANNELLI SOLARI *solar panels*

Detergente pronto all'uso.  
Ideale per la pulizia di pannelli solari ed impianti fotovoltaici.  
Piacevole fragranza di lavanda.  
Formulazione esente da EDTA e NTA e conservanti privi di formaldeide ed alogeni.

*Ready-to-use cleaner.  
Ideal for cleaning solar panels and photovoltaic systems.  
Pleasant lavender scent.  
Formula free from EDTA and NTA and preservatives without formaldehyde or halogens.*

Cod. 43485



## BICI&MOTO *bicycle and motorbikes*

Detergente pronto all'uso.  
Ideale per la pulizia di superfici delicate quali la vernice di telai di bici e moto.  
Rimuove alla perfezione tracce di fango ed olio.  
Piacevole fragranza di bouquet fiorito.  
Formulazione esente da EDTA e NTA e conservanti privi di formaldeide ed alogeni.

*Ready-to-use cleaner.  
Ideal for cleaning delicate surfaces such as the paintwork of bike and motorbike frames. Removes mud and oil residues to perfection.  
Pleasant floral scent.  
Formula free from EDTA and NTA and preservatives without formaldehyde or halogens.*

Cod. 41871



## ERBA SINTETICA *synthetic grass*

Detergente pronto all'uso.  
Ideale per pulire superfici in erba sintetica. Rimuove lo sporco che si annida alla base senza danneggiarne la consistenza e la forma.  
Piacevole fragranza di pino selvatico.  
Formulazione esente da EDTA e NTA e conservanti privi di formaldeide ed alogeni.

*Ready-to-use cleaner.  
Ideal for cleaning artificial turf surfaces. Removes the dirt that builds up at the base without damaging the turf's consistency or shape.  
Pleasant wild pine scent.  
Formula free from EDTA and NTA and preservatives without formaldehyde or halogens.*

Cod. 43484



## DECKING *wood surfaces*

Detergente pronto all'uso.  
Pulisce senza danneggiare tutte le pavimentazioni in decking e legno, sia trattato che naturale.  
Piacevole fragranza alla vaniglia.  
Formulazione esente da EDTA e NTA e conservanti privi di formaldeide e alogeni.

*Ready-to-use cleaner.  
Cleans all treated and untreated decking and wood floors without damaging surfaces.  
Pleasant vanilla scent.  
Formula free from EDTA and NTA and preservatives without formaldehyde or halogens.*

Cod. 43487



## MURI&PIETRE *walls and stones*

Detergente pronto all'uso.  
Pulisce le superfici in pietra naturale, in sasso e facciate in muratura, rimuovendo anche lo sporco più ostinato.  
Fragranza di sapone di Marsiglia.  
Formulazione esente da EDTA e NTA e conservanti privi di formaldeide ed alogeni.

*Ready-to-use cleaner.  
Cleans natural and dressed stone surfaces and brickwork facades, removing even the most stubborn dirt.  
Savon de Marseille scent.  
Formula free from EDTA and NTA and preservatives without formaldehyde or halogens.*

Cod. 43486







## TENDE DA SOLE *awnings*

Detergente pronto all'uso. Ideale per la pulizia di teli in tessuto e plastica. Rimuove con facilità lo sporco che si accumula sulle strutture all'aperto. Piacevole fragranza agli agrumi. Formulazione esente da EDTA e NTA e conservanti privi di formaldeide ed alogeni.

*Ready-to-use cleaner. Ideal for cleaning fabric and plastic blinds. Easily removes the dirt that builds up on outdoor structures. Pleasant citrus scent. Formula free from EDTA and NTA and preservatives without formaldehyde or halogens.*



## VETRI *glass*

Detergente pronto all'uso. Ideale per la pulizia di superfici in vetro, trasparenti o riflettenti. Rimuove lo sporco senza lasciare aloni e striature. Delicata fragranza fresco di pulito. Formulazione esente da EDTA e NTA e conservanti privi di formaldeide ed alogeni.

*Ready-to-use cleaner. Ideal for cleaning clear or reflecting glass surfaces. Removes dirt without leaving smears or streaks. Delicate, clean scent. Formula free from EDTA and NTA and preservatives without formaldehyde or halogens.*



## UNIVERSALE *universal*

Detergente pronto all'uso. Rimuove facilmente lo sporco accumulato sulle strutture outdoor in plastica, ceramica e metallo. Delicata fragranza di pesca. Formulazione esente da EDTA e NTA e conservanti privi di formaldeide ed alogeni.

*Ready-to-use cleaner. Easily removes the dirt that builds up on outdoor plastic, ceramic and metal structures. Delicate peach scent. Formula free from EDTA and NTA and preservatives without formaldehyde or halogens.*

Cod. 43483 11e 

Cod. 43488 11e 

Cod. 41870 (1l) 11e   
 Cod. 43491(5l) 51e



## HYG

Detergente igienizzante pronto all'uso per la sanificazione dell'esterno casa. Utilizzato in combinazione con la tua idropulitrice ad alta pressione aiuta a ridurre la carica batterica. HYG lascia una gradevole sensazione di pulito e freschezza grazie al suo profumo di limone.

**AGISCE IN MODO MECCANICO CON L'ASPORTAZIONE DELLO SPORCO**

*Ready-to-use sanitizing detergent for external home surfaces and furnitures. Use it with your high pressure washer to reduce the bacterial count. HYG gives a nice cleaning lemon scent. It works mechanically with dirt removal.*

Cod. 46705 (1l) 11e  
 Cod. 46706 (5l) 51e  
 Cod. 46707 (12l) 121e







# 1.3.4.5 Series

## ACCESSORI accessories

		1 Series	3 Series	DSS Series	DHS	DTS Series	4 Series	5 Series	BC250				
		117	143	387	2.0 PE	3.0 PE	2.A	4.0 TF	5.0 TF	4.1	492	587	BC250
Pistola Trigger gun		41559	S	S									
		46328	O	O	S	S	S	S	S	S	S		
		47047								S			
		4381913									S	S	
Pistola Trigger gun		46844				S							
		41563 (42 cm)	S	S									
Prolunga lancia Lance extension		46332 (42 cm)		S	S	S	S	S	S	S			
		47048 (35 cm)								S			
		47341 (26 cm)	O	O	O	O	O	O	O	O	O	O	O
Portatestina doppio Twin nozzle holder		46337				S	S	S					
Testina getto regolabile Adjustable jet nozzle		41564	S	S									
		46327		S	S	S							
		46540		S		S							
		46330					S	O	S				
Testina getto rotante Rotary jet nozzle		41565	O	S	S	S	S	S					
		46329					S	S	S				
		46338	O	O									
Testina cinque in uno Five in One nozzle		46341		O	O	O							
		46544		O		O							
		46342					O	S	O				
Lancia getto regolabile Lance with adjustable spray nozzle		47685							S				
		47686								S			
Lancia getto rotante Rotary lance		46578						S	S				
Lancia Lance		46845				S							
		46846 (6 m)				S							
Tubo irroratore Spraying hose		46348 (3 m)	S										
		41560 (5 m)	O	S									
		46541 (6 m)		S	S	S	S						
		46335 (8 m)					S	S					
Tubo AP Hose HP		46678 (8 m)						S					

		1 Series	3 Series	DSS Series	DHS	DTS Series	4 Series	5 Series	BC250				
		117	143	387	2.0 PE	3.0 PE	2.A	4.0 TF	5.0 TF	4.1	492	587	BC250
Tubo armato AP Reinforced hose HP		43987 (8 m)									S	S	
Prolunga tubo AP Extension HP hose		41585 (8 m)	O	O									
		46336 (8 m)		O	O	O	O	O	O	O	O	O	O
Prolunga tubo Extension hose		46847 (6 m)					O						
Prolunga tubo armato AP Extension reinforced HP hose		41587 (8 m)									O	O	
Kit schiumogeno Foam lance bottle		41570 (400 ml)	S	S									
		47339 (400 ml)		S	S								
Kit schiumogeno alta pressione High pressure foam lance bottle		46343 (750 ml)	O	O	O	O	O	O	O				
		46572 (400 ml)	O	O	O	O	S	S	O				
		46344 (600 ml)						S	S	S			
		46580 (600 ml)									O	O	
Lancia multifunzione Multifunction lance		46345 (750 ml)									O	O	
		46349 (48 cm)	O	O									
		46352 (48 cm)			O	O	O						
Kit pulizia tubazioni Pipe drain kit		46545 (48 cm)		O		O							
		43827 (8 m)	O	O	O	O	O	O					
		41588 (10 m)	O	O	O	O	O	O	O	O	O	O	O
Spazzola fissa Fixed brush		41693 (16 m)	O	O	O	O	O	O	O	O	O	O	O
		41577	O	O	O	O	O	O	O	O	O	O	O
Spazzola fissa Fixed brush		46353	O	O	O	O	O	O	O	O	O	O	O

Legenda: "S" Accessorio di serie - "O" Accessorio opzionale  
"S" On board accessory - "O" Optional accessory

# 1.3.4.5 Series

## ACCESSORI accessories



		1 Series	143	3 Series	397	2.0 PE	3.0 PE	DHS	2.A	4.0 TF	5.0 TF	4.1	492	5 Series	BC250
Spazzola rotante <i>Rotary brush</i>		41578	○	○	○	○	○	○	○	○	○	○	○	○	○
Spazzola lavante <i>Power brush</i>		46361	○	○	○	○	○	○						○	○
		46362							○	○	○				
Lavapavimenti d. 25 cm <i>Patio cleaner d. 25 cm</i>		46356	○	○	○	S	S	○						○	○
Lavapavimenti d. 30 cm con serbatoio detergente <i>Patio cleaner d. 30 cm with detergent tank</i>		41581	○	○	○	○	○	○						○	
Lavapavimenti d. 30 cm <i>Patio cleaner d. 30 cm</i>		46358	○	○	○	○	○	○						○	
		46359												○	
Aquasweeper <i>Aquasweeper</i>		46686	○	○	○	○	○	○	○	○	○	○	○	○	○
Kit lancia sabbiante <i>Sandblasting lance kit</i>		41760 (50 cm)	○	○	○	○	○	○							
		47108 (50 cm)							○	○	○				
Kit lancia sabbiante PRO <i>Sandblasting lance kit PRO</i>		41591 (50 cm)												○	
		41762 (50 cm)												○	
Sabbia calibrata e filtrata <i>Calibrated, filtered sand</i>		3207 (5 Kg)	○	○	○	○	○	○	○	○	○	○	○	○	○
		41770 (25 Kg)	○	○	○	○	○	○	○	○	○	○	○	○	○
Kit aspirazione acqua <i>Water suction kit</i>		41592	○	○	○	○	○	○	○	○	○	○	○	○	○
Kit adescamento <i>selfpriming kit</i>		47332	○	○	○	○	○	○	○	○	○	○	○	○	○
Adattatore snodato per testine <i>Adjustable head nozzle adaptor</i>		46009	○	○	○	○	○	○	○	○					
Kit lancia sottoscocca <i>Underbody lance kit</i>		46354												○	○
Kit estensione lancia 1,6 m <i>Extension lance kit 1,6 m</i>		46355	○	○	○	○	○	○	○	○	○	○	○	○	○
Kit adattatori <i>Adaptors kit</i>		41758	○	○	○	○	○	○	○	○	○	○	○	○	○

		1 Series	143	3 Series	397	2.0 PE	3.0 PE	DHS	2.A	4.0 TF	5.0 TF	4.1	492	5 Series	BC250
Kit adattatori accessori <i>Accessories adapters kit</i>		41890*	○	○	○	○	○	○	○	○	○	○	○	○	○
Kit filtro acqua <i>Water filter kit</i>		41593	○	○	○	○	○	○	○	○	○	○	○	○	○
Kit attacco rapido <i>Click fast kit</i>		41580	○	○	○	○	○	○	○	○	○	○	○	○	○
Filtro acqua ispezionabile <i>Inspectable water filter</i>		41663 (3 pcs)	S	S	S	S	S	S	S	S	S	S	S	S	S
Prolunga lancia <i>Lance extension</i>		5120011													S
Testina quattro in uno <i>Four in One nozzle</i>		5120040													S
Kitschiumogeno <i>Foam lance bottle</i>		5120031													S
Kit autoadescamento <i>Self-priming kit</i>		5120051													S
Batteria al litio <i>Lithium battery</i>		5120071													S
Caricabatterie rapido <i>Fast battery charger</i>		5120190													S

(\*) Adattatori universali da collegarsi ad accessori con attacco a baionetta AR Blue Clean, compatibili con idropultrici ad alta pressione aventi analoghe prestazioni di quelle indicate in tabella

(\*) Universal adaptors to be connected to Blue Clean accessories with bayonet fitting, suitable for pressure washers with similar specifications of the models listed in the chart

**LINEA  
PROFES-  
SIONAL**

*Professional line*

# PRO COLD



Prodotti tecnicamente pensati per resistere ad utilizzi gravosi e continuativi. Una gamma completa per soddisfare le diverse esigenze lavorative di professionisti che ricercano ogni giorno qualità, prestazioni affidabili e velocità d'utilizzo. In due parole la qualità Annovi Reverberi. È questo il denominatore comune della gamma PRO COLD – idropulitrici ad acqua fredda costruite con pompe ad elevate prestazioni per garantire alla macchina una extra durata anche in condizioni di utilizzo gravose ed estreme. Ideali per il settore Automotive e per cantieri edili.

*Products engineered to withstand continual heavy-duty use. A complete range to meet the various working needs of professionals who need quality, reliable performance and fast operation, day in, day out. In other words, Annovi Reverberi quality. This is the common denominator of the PRO COLD range – cold water high pressure washers built with high-performance pumps to guarantee an exceptionally long lifetime even in extreme, heavy-duty conditions. Ideal for the automotive industry and construction sites.*

# Applicazioni ed indicatori di prestazioni PRO COLD

*PRO COLD performance*  
*Indicators & Applications*  
BLUE CLEAN PRO LEVEL

## ○ LIGHTPRO

Fascia di idropultrici progettate per utilizzatori esperti che hanno necessità di eseguire lavori di pulizia abbastanza frequenti e che richiedono una abbondante riserva di potenza.

*High pressure washer category designed for skilled users tackling cleaning quite frequent jobs operations which need plenty of power in reserve.*

## ● HEAVYPRO

Fascia di idropultrici progettate per professionisti che hanno necessità di eseguire lavori di pulizia molto frequenti che richiedono le massime prestazioni.

*High pressure cleaner category designed for professionals, dealing with cleaning high frequent jobs that need the very highest-performing appliances.*

## BLUE CLEAN FACTOR



La combinazione ideale tra prestazioni tecniche e configurazione commerciale per poter risolvere al meglio le tue esigenze di pulizia. I prodotti che hanno il BLUE FACTOR sono i migliori, all'interno della loro categoria, per poter pulente, facilità d'utilizzo e prestazioni tecniche. Il mix perfetto per ogni tua esigenza di pulizia.

*The ideal combination of technical features and commercial configuration, to deliver the best solution to your cleaning needs. Products with the BLUE FACTOR are best-in-class in cleaning power, ease of use and technical performances. The perfect mix for all your cleaning requirements.*







# Applicazioni PRO COLD

PRO COLD  
Applications

## PROFESSIONAL APPLICATIONS

Annovi Reverberi ha realizzato una gamma di prodotti, ideale per gli artigiani più esigenti, che ben si coniuga alle loro esigenze professionali. Estremamente versatili i prodotti della linea PRO rispondono perfettamente alle necessità lavorative di artigiani idraulici, carrozzieri, muratori; un costante supporto a ciascuna professione che consente risparmio tempo ma soprattutto fatica. Utilizzo intuitivo, accessori professionali e manovrabilità estrema rendono i prodotti ARBC la miglior scelta per la categoria.

*Annovi Reverberi has produced a range of products ideal for the most demanding craftsmen, carefully tailored to their professional requirements. Extremely versatile, the PRO line products are the perfect fit for the working needs of plumbers, car body repair workshops and builders; constant support for each trade, saving time and above all effort. User-friendliness, professional accessories and extremely easy handling make ARBC products the right choice for this category.*



**edilizia**  
construction



**agricoltura  
zootecnica**  
agriculture  
zootechny



**artigianato**  
crafts



**car wash**



**automotive**



### 5 Series

589



●	●	●		
---	---	---	--	--

591



●	●	●		
---	---	---	--	--

### 7 Series

7.0



●	●	●		
---	---	---	--	--

### 6 Series

611



●	●	●		
---	---	---	--	--

613



●	●	●		
---	---	---	--	--

614

613K



●	●	●		
---	---	---	--	--

614K

630



●	●	●		
---	---	---	--	--

630K



●	●	●		
---	---	---	--	--

670



●	●	●		
---	---	---	--	--

671

680



●	●	●		
---	---	---	--	--

680K



●	●	●		
---	---	---	--	--

### 7 Series

780



●	●	●		●
---	---	---	--	---

787



●	●	●		●
---	---	---	--	---



**9 Series**

930	<input checked="" type="checkbox"/>	<input checked="" type="checkbox"/>	<input checked="" type="checkbox"/>	<input checked="" type="checkbox"/>	<input checked="" type="checkbox"/>
-----	-------------------------------------	-------------------------------------	-------------------------------------	-------------------------------------	-------------------------------------

960 	<input checked="" type="checkbox"/>	<input checked="" type="checkbox"/>	<input checked="" type="checkbox"/>	<input checked="" type="checkbox"/>	<input checked="" type="checkbox"/>
---	-------------------------------------	-------------------------------------	-------------------------------------	-------------------------------------	-------------------------------------

980	<input checked="" type="checkbox"/>	<input checked="" type="checkbox"/>	<input checked="" type="checkbox"/>	<input checked="" type="checkbox"/>	<input checked="" type="checkbox"/>
-----	-------------------------------------	-------------------------------------	-------------------------------------	-------------------------------------	-------------------------------------

**10 Series**

1003 1003XE 1003RLW	<input checked="" type="checkbox"/>	<input checked="" type="checkbox"/>	<input checked="" type="checkbox"/>	<input checked="" type="checkbox"/>	<input checked="" type="checkbox"/>
---------------------------	-------------------------------------	-------------------------------------	-------------------------------------	-------------------------------------	-------------------------------------

1005 	<input checked="" type="checkbox"/>	<input checked="" type="checkbox"/>	<input checked="" type="checkbox"/>	<input checked="" type="checkbox"/>	<input checked="" type="checkbox"/>
---	-------------------------------------	-------------------------------------	-------------------------------------	-------------------------------------	-------------------------------------

1006XE	<input checked="" type="checkbox"/>	<input checked="" type="checkbox"/>	<input checked="" type="checkbox"/>	<input checked="" type="checkbox"/>	<input checked="" type="checkbox"/>
--------	-------------------------------------	-------------------------------------	-------------------------------------	-------------------------------------	-------------------------------------

1007 1007XE 1007RLW	<input checked="" type="checkbox"/>	<input checked="" type="checkbox"/>	<input checked="" type="checkbox"/>	<input checked="" type="checkbox"/>	<input checked="" type="checkbox"/>
---------------------------	-------------------------------------	-------------------------------------	-------------------------------------	-------------------------------------	-------------------------------------

1009 	<input checked="" type="checkbox"/>	<input checked="" type="checkbox"/>	<input checked="" type="checkbox"/>	<input checked="" type="checkbox"/>	<input checked="" type="checkbox"/>
--	-------------------------------------	-------------------------------------	-------------------------------------	-------------------------------------	-------------------------------------

1015 	<input checked="" type="checkbox"/>	<input checked="" type="checkbox"/>	<input checked="" type="checkbox"/>	<input checked="" type="checkbox"/>	<input checked="" type="checkbox"/>
--	-------------------------------------	-------------------------------------	-------------------------------------	-------------------------------------	-------------------------------------

1018 1018H 	<input checked="" type="checkbox"/>	<input checked="" type="checkbox"/>	<input checked="" type="checkbox"/>	<input checked="" type="checkbox"/>	<input checked="" type="checkbox"/>
---	-------------------------------------	-------------------------------------	-------------------------------------	-------------------------------------	-------------------------------------

1120 	<input checked="" type="checkbox"/>	<input checked="" type="checkbox"/>	<input checked="" type="checkbox"/>	<input checked="" type="checkbox"/>	<input checked="" type="checkbox"/>
--	-------------------------------------	-------------------------------------	-------------------------------------	-------------------------------------	-------------------------------------



**11 Series**

1415 	<input checked="" type="checkbox"/>	<input checked="" type="checkbox"/>	<input type="checkbox"/>	<input type="checkbox"/>	<input type="checkbox"/>
--	-------------------------------------	-------------------------------------	--------------------------	--------------------------	--------------------------

**14 Series**

1425 	<input checked="" type="checkbox"/>	<input checked="" type="checkbox"/>	<input type="checkbox"/>	<input type="checkbox"/>	<input type="checkbox"/>
--	-------------------------------------	-------------------------------------	--------------------------	--------------------------	--------------------------

1435 	<input checked="" type="checkbox"/>	<input checked="" type="checkbox"/>	<input checked="" type="checkbox"/>	<input type="checkbox"/>	<input type="checkbox"/>
--	-------------------------------------	-------------------------------------	-------------------------------------	--------------------------	--------------------------

1440 	<input checked="" type="checkbox"/>	<input checked="" type="checkbox"/>	<input checked="" type="checkbox"/>	<input type="checkbox"/>	<input type="checkbox"/>
--	-------------------------------------	-------------------------------------	-------------------------------------	--------------------------	--------------------------

1445 	<input checked="" type="checkbox"/>	<input checked="" type="checkbox"/>	<input checked="" type="checkbox"/>	<input type="checkbox"/>	<input type="checkbox"/>
---	-------------------------------------	-------------------------------------	-------------------------------------	--------------------------	--------------------------

1445XE 	<input checked="" type="checkbox"/>	<input checked="" type="checkbox"/>	<input checked="" type="checkbox"/>	<input type="checkbox"/>	<input type="checkbox"/>
--	-------------------------------------	-------------------------------------	-------------------------------------	--------------------------	--------------------------

1447 	<input checked="" type="checkbox"/>	<input checked="" type="checkbox"/>	<input checked="" type="checkbox"/>	<input checked="" type="checkbox"/>	<input type="checkbox"/>
--	-------------------------------------	-------------------------------------	-------------------------------------	-------------------------------------	--------------------------

1450 	<input checked="" type="checkbox"/>	<input checked="" type="checkbox"/>	<input checked="" type="checkbox"/>	<input checked="" type="checkbox"/>	<input type="checkbox"/>
--	-------------------------------------	-------------------------------------	-------------------------------------	-------------------------------------	--------------------------

1460 	<input type="checkbox"/>	<input type="checkbox"/>	<input type="checkbox"/>	<input type="checkbox"/>	<input type="checkbox"/>
--	--------------------------	--------------------------	--------------------------	--------------------------	--------------------------

1475 1475XE 	<input checked="" type="checkbox"/>	<input checked="" type="checkbox"/>	<input checked="" type="checkbox"/>	<input checked="" type="checkbox"/>	<input checked="" type="checkbox"/>
--	-------------------------------------	-------------------------------------	-------------------------------------	-------------------------------------	-------------------------------------

1480 	<input checked="" type="checkbox"/>	<input checked="" type="checkbox"/>	<input checked="" type="checkbox"/>	<input checked="" type="checkbox"/>	<input checked="" type="checkbox"/>
--	-------------------------------------	-------------------------------------	-------------------------------------	-------------------------------------	-------------------------------------

1490 	<input checked="" type="checkbox"/>	<input checked="" type="checkbox"/>	<input checked="" type="checkbox"/>	<input checked="" type="checkbox"/>	<input checked="" type="checkbox"/>
--	-------------------------------------	-------------------------------------	-------------------------------------	-------------------------------------	-------------------------------------

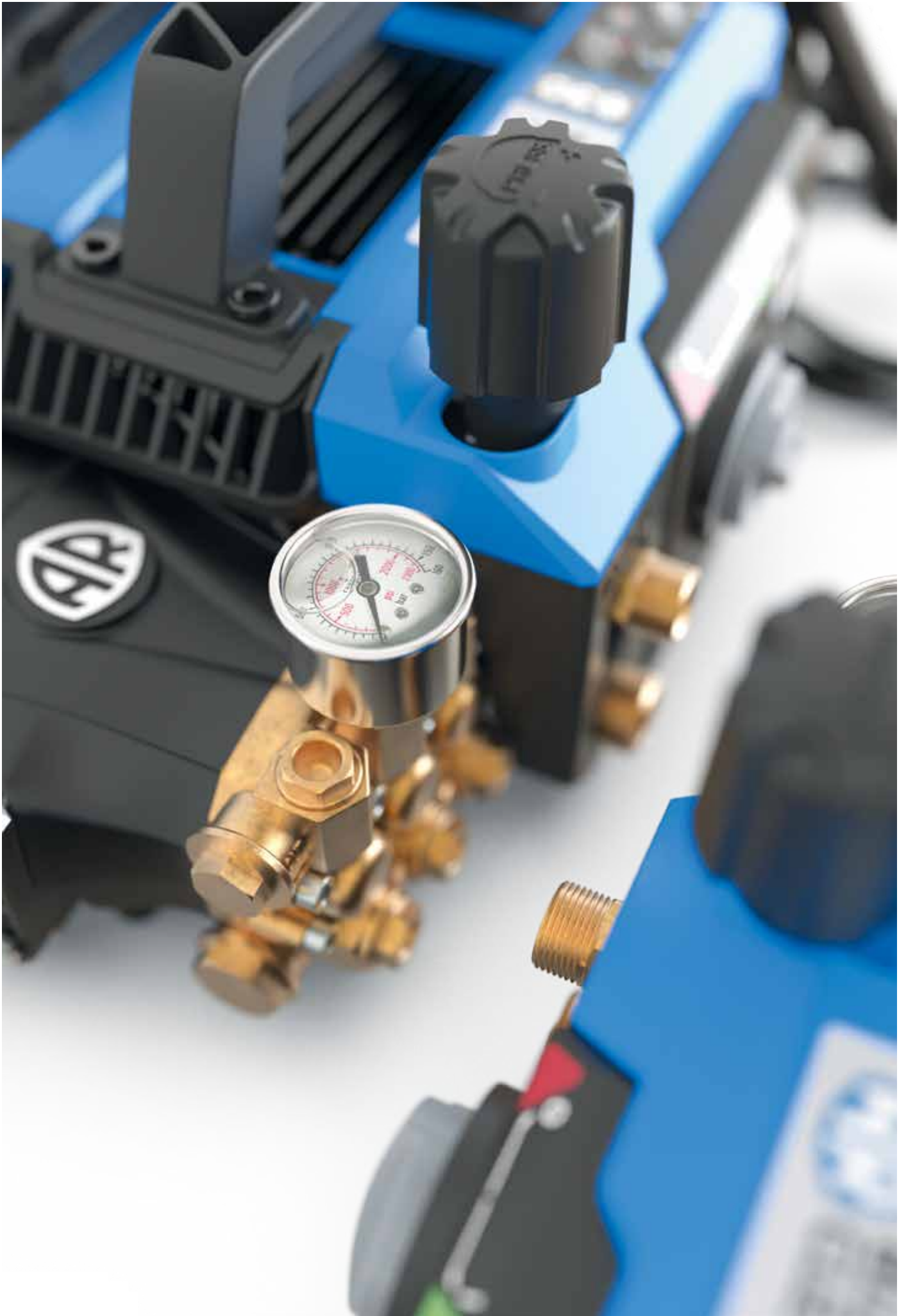



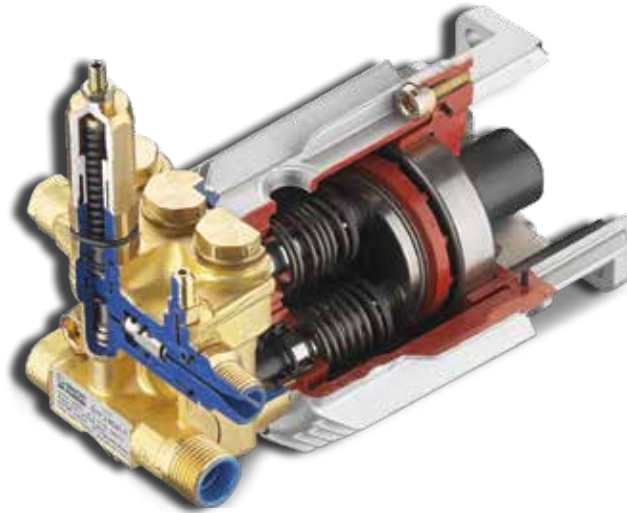

Pompa a piattello oscillante di dimensioni ridotte per utilizzo sia ad asse orizzontale che verticale.

Corpo pompa realizzato in lega d'alluminio per un'alta resistenza.

Il piattello oscillante è sempre realizzato in lega d'alluminio con un particolare trattamento antiusura. I componenti interni sono tutti di dimensioni maggiorate in grado così di garantire una buona affidabilità anche in condizioni di lavoro particolarmente gravoso.

*Compact wobble-plate pump for use both horizontal and vertical.*

*Aluminium alloy pump body for high strength.*

*The wobble plate is also in aluminium alloy with a special wear-resistant coating. Internal components are all oversized, to guarantee excellent reliability even in particularly heavy-duty conditions.*

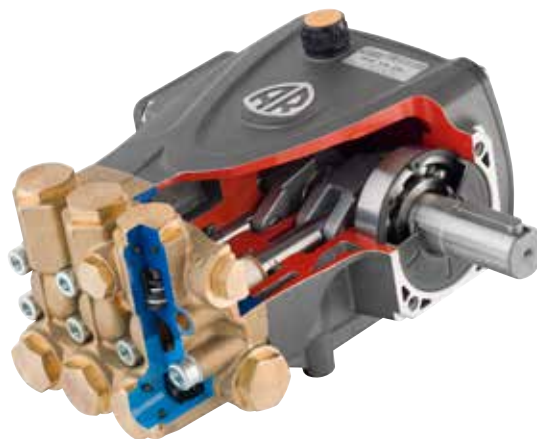

Pompa con sistema biella-manovella per utilizzo in orizzontale. Corpo e coperchi laterali con livello olio. Bielle in lega zinco-alluminio pressofuso. Testa in ottone forgiato con disegno ad alta resistenza. Pistoni in ceramica. Sistema di tenuta a doppia guarnizione. I componenti interni sono tutti di dimensioni maggiorate in grado di garantire una buona affidabilità e resistenza nel tempo.

*Wobble plate pump for orizontal use. Crankcase and side covers with oil level. Connecting rods in die-cast zinc-aluminium alloy. High strength forged brass head with design. Ceramic plungers. Double seal sealing system. The internal components are all oversized to ensure good reliability and durability.*



## HRM-O

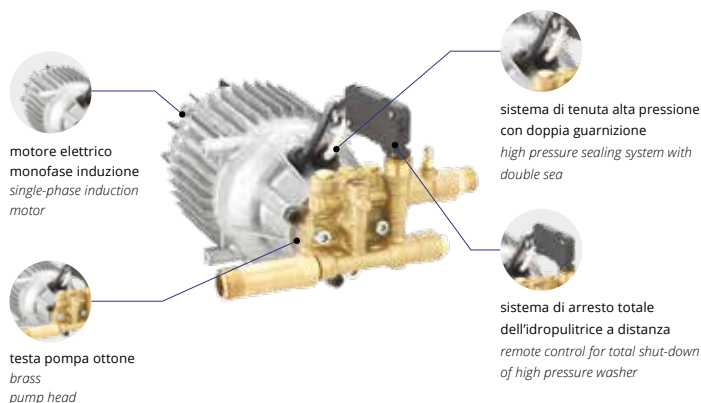

- Pompa a 3 pistoni assiali comandati dal piattello oscillante
- Pistoni in acciaio inox temperato
- Testa pompa in ottone
- Valvola di sicurezza automatica con azzeramento della pressione nella testa pompa
- Motore elettrico monofase a induzione con protezione termica
- Sistema di arresto totale dell'idropulitrice a distanza
- Sistema di tenuta alta pressione con doppia guarnizione (mod. 589/591/7.0)
- Aspirazione acqua da serbatoio con funzione autoadescente

- 3 Axial stainless steel pistons wobble-plate pump
- Tempered stainless steel pistons
- Brass pump head
- Automatic by-pass valve with pump head pressure discharge
- Single-phase induction motor with thermal protector
- Remote control for total shut-down of high pressure washer
- High pressure sealing system with double seal (mod. 589/591/7.0)
- Inlet water suction from tank by self priming function



## HJRS-A



- Pompa a 3 pistoni in ceramica con sistema biella-manovella, testa pompa in alluminio
- Valvola di sicurezza automatica con azzeramento della pressione nella testa pompa
- Motore elettrico monofase a induzione con protezione termica
- Sistema di arresto totale dell'idropulitrice a distanza
- Aspirazione acqua da serbatoio con funzione autoadescente

- Triplex pump with ceramic pistons and connecting rod system with aluminium pump head
- Automatic by-pass valve with pump head pressure discharge
- Single-phase induction motor with thermal protection
- Remote control for total shut-down of high pressure washer
- Inlet water suction from tank by self priming function



## HPV-O

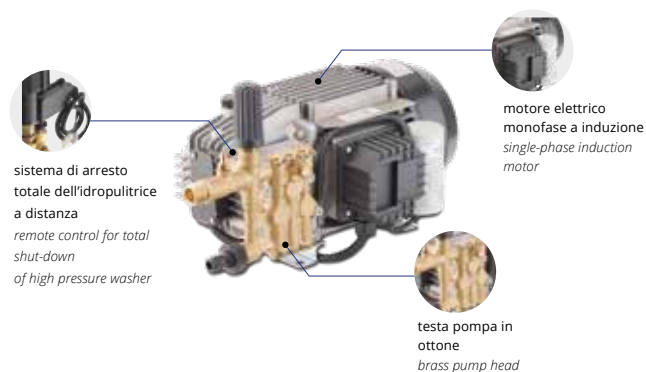

- Pompa a 3 pistoni in acciaio inox temperato con riporto ceramico con sistema biella-manovella, testa pompa in ottone
- Valvola di sicurezza automatica con azzeramento della pressione nella testa pompa
- Motore elettrico monofase a induzione con protezione termica
- Sistema di arresto totale dell'idropulitrice a distanza
- Aspirazione acqua da serbatoio con funzione autoadescente

- Triplex pump with tempered stainless steel ceramic coated pistons and connecting rod system with brass pump head
- Automatic by-pass valve with pump head pressure discharge
- Single-phase induction motor with thermal protection
- Remote control for total shut-down of high pressure washer
- Inlet water suction from tank by self priming function



## HJRS-O



- Pompa a 3 pistoni in acciaio inox temperato con riporto ceramico con sistema biella-manovella, testa pompa in ottone
- Valvola di sicurezza automatica con azzeramento della pressione nella testa pompa
- Motore elettrico monofase a induzione con protezione termica
- Sistema di arresto totale dell'idropulitrice a distanza
- Aspirazione acqua da serbatoio con funzione autoadescente

- *Triplex pump with tempered stainless steel ceramic coated pistons and connecting rod system with brass pump head*
- *Automatic by-pass valve with pump head pressure discharge*
- *Single-phase induction motor with thermal protection*
- *Remote control for total shut-down of high pressure washer*
- *Inlet water suction from tank by self priming function*



## HRS



- Pompa a 3 pistoni in ceramica con sistema biella-manovella, testa pompa in ottone
- Valvola di sicurezza automatica con azzeramento della pressione nella testa pompa
- Motore elettrico monofase a induzione con protezione termica
- Motore elettrico trifase a induzione con protezione termica
- Sistema di arresto totale dell'idropulitrice a distanza

- *Triplex pump with ceramic pistons and connecting rod system with brass pump head*
- *Automatic by-pass valve with pump head pressure discharge*
- *Single-phase induction motor with thermal protection*
- *Three-phase induction motor with thermal protection*
- *Remote control for total shut-down of high pressure washer*



## HRC

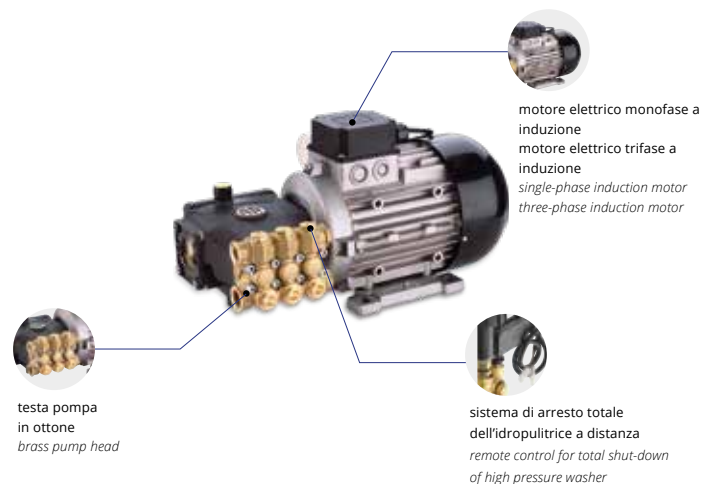

- Pompa a 3 pistoni in ceramica con sistema biella-manovella, testa pompa in ottone
- Valvola di bypass automatica con azzeramento della pressione nella testa pompa (630.630K)
- Motore elettrico a induzione con protezione termica (3kW)
- Sistema di arresto totale dell'idropulitrice a distanza
- Aspirazione acqua da serbatoio con funzione autoadescente

- *Triplex pump with ceramic pistons and connecting rod system with brass pump head*
- *Automatic by-pass valve with pump head pressure discharge (630.630K)*
- *Induction motor with thermal protection*
- *Remote control for total shut-down of high pressure washer*
- *Inlet water suction from tank by self priming function*



## HRR

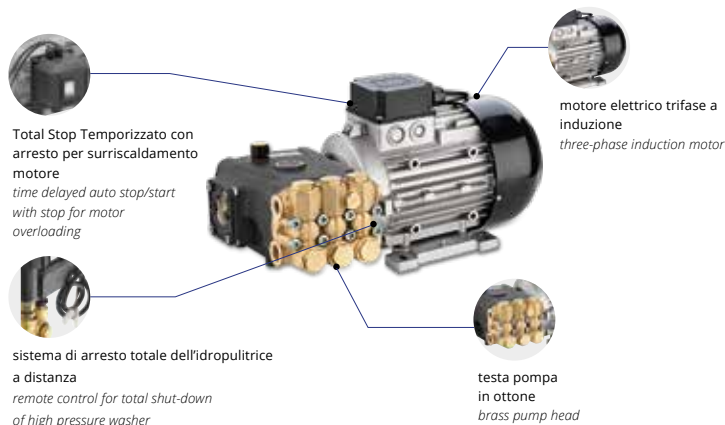

- Pompa a 3 pistoni in ceramica con sistema biella-manovella, testa pompa in ottone
- Valvola di bypass automatica con azzeramento della pressione nella testa pompa
- Motore elettrico trifase a induzione con protezione termica
- Sistema di arresto totale dell'idropulitrice a distanza
- Total Stop Temporizzato (per mod. 980,1007,1015)
- Aspirazione acqua da serbatoio con funzione autoadescente

- *Triplex pump with ceramic pistons and connecting rod system with brass pump head*
- *Automatic by-pass valve with pump head pressure discharge*
- *Three-phase induction motor with thermal protection*
- *Remote control for total shut-down of high pressure washer*
- *Time delayed auto stop/start with stop for motor overloading*
- *Inlet water suction from tank by self priming function*



## HRK

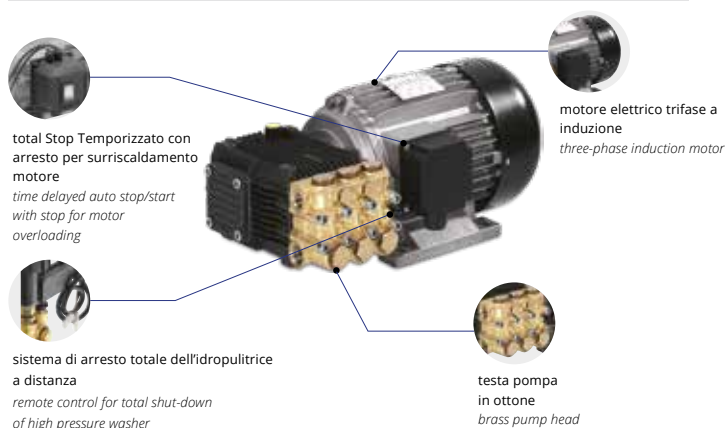

- Pompa a 3 pistoni in ceramica con sistema biella-manovella, testa pompa in ottone
- Valvola di bypass automatica con azzeramento della pressione nella testa pompa
- Motore elettrico trifase a induzione con protezione termica
- Total Stop Temporizzato
- Aspirazione acqua da serbatoio con funzione autoadescente

- *Triplex pump with ceramic pistons and connecting rod system with brass pump head*
- *Automatic by-pass valve with pump head pressure discharge*
- *Three-phase induction motor with thermal protection*
- *Remote control for total shut-down of high pressure washer*
- *Time delayed auto stop/start with stop for motor overloading*
- *Inlet water suction from tank by self priming function*



## HRW

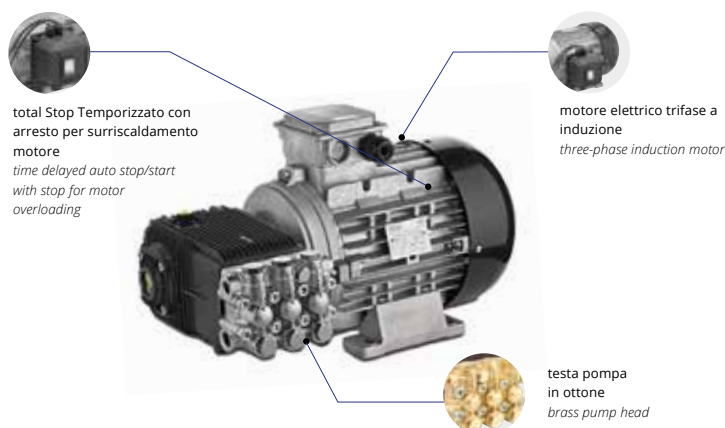

- Pompa a 3 pistoni in ceramica con sistema biella-manovella, testa pompa in ottone
- Valvola di bypass automatica con azzeramento della pressione nella testa pompa
- Motore elettrico trifase a induzione con protezione termica
- Total Stop Temporizzato
- Aspirazione acqua da serbatoio con funzione autoadescente

- *Triplex pump with ceramic pistons and connecting rod system with brass pump head*
- *Automatic by-pass valve with pump head pressure discharge*
- *Three-phase induction motor with thermal protection*
- *Time delayed auto stop/start with stop for motor overloading*
- *Inlet water suction from tank by self priming function*



## WHW

total Stop Temporizzato con arresto per surriscaldamento motore  
time delayed auto stop/start with stop for motor overloading



- Pompa a 3 pistoni in ceramica con sistema biella-manovella, testa pompa in ottone
- Valvola di bypass automatica con azzeramento della pressione nella testa pompa
- Motore elettrico trifase a induzione con protezione termica
- Total Stop Temporizzato
- Guarnizioni in teflon che permettono di utilizzare acqua ad una temperatura massima in ingresso di 85°

- Triplex pump with ceramic pistons and connecting rod system with brass pump head
- Automatic by-pass valve with pump head pressure discharge
- Three-phase induction motor with thermal protection
- Time delayed auto stop/start with stop for motor overloading
- Inlet water suction from tank by self priming function
- Teflon gasket to allow cleaning at high temperature. Max inlet water temperature 85°



## HXW

total Stop Temporizzato con arresto per surriscaldamento motore  
time delayed auto stop/start with stop for motor overloading

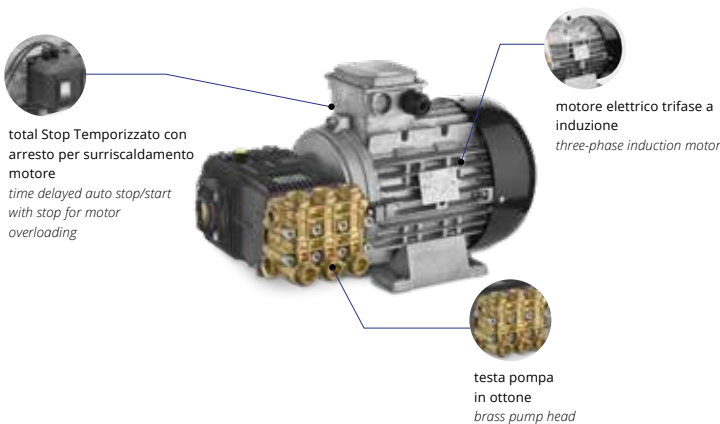

- Pompa a 3 pistoni in ceramica con sistema biella-manovella, testa pompa in ottone
- Valvola di bypass automatica con azzeramento della pressione nella testa pompa
- Motore elettrico trifase a induzione con protezione termica
- Total Stop Temporizzato
- Aspirazione acqua da serbatoio con funzione autoadescente

- Triplex pump with ceramic pistons and connecting rod system with brass pump head
- Automatic by-pass valve with pump head pressure discharge
- Three-phase induction motor with thermal protection
- Time delayed auto stop/start with stop for motor overloading
- Inlet water suction from tank by self priming function



## RPV

testa pompa in alluminio  
aluminum pump head

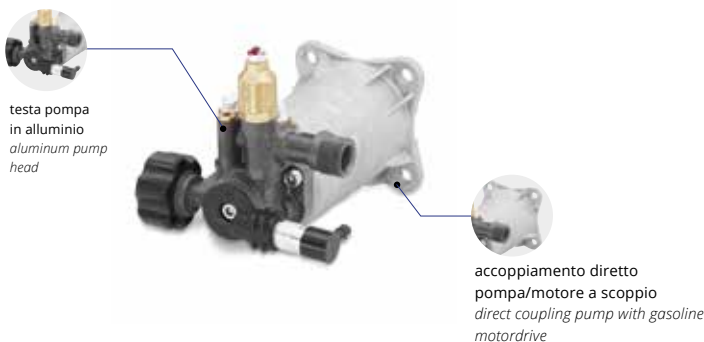

- Pompa a 3 pistoni assiali comandati dal piattello oscillante, testa alluminio
- Pistoni in acciaio inox temperato
- Valvola di sicurezza automatica con azzeramento della pressione nella testa pompa
- Accoppiamento diretto pompa/motore a scoppio
- Aspirazione acqua da serbatoio con funzione autoadescente

- 3 Axial stainless steel pistons wobble-plate pump with aluminum head
- Tempered stainless steel pistons
- Automatic by-pass valve with pump head pressure discharge
- Direct coupling pump with gasoline motor
- Inlet water suction from tank by self priming function





## RMW



- Pompa a 3 pistoni assiali comandati dal piattello oscillante, testa alluminio
- Pistoni in acciaio inox temperato
- Valvola di sicurezza automatica con azzeramento della pressione nella testa pompa
- Accoppiamento diretto pompa/motore a scoppio
- Aspirazione acqua da serbatoio con funzione autoadescente
- 3 Axial stainless steel pistons wobble-plate pump with aluminum head
- Tempered stainless steel pistons
- Automatic by-pass valve with pump head pressure discharge
- Direct coupling pump with gasoline motor
- Inlet water suction from tank by self priming function



## RMV

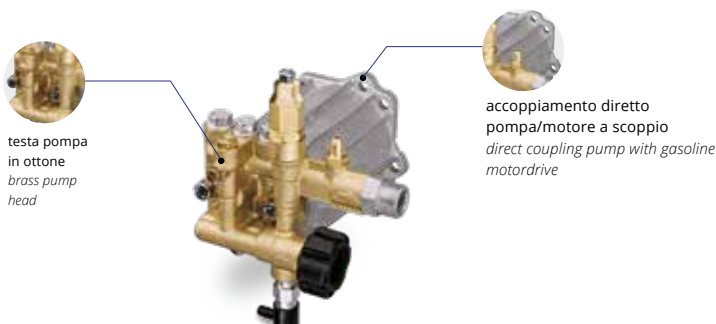

- Pompa a 3 pistoni assiali comandati dal piattello oscillante, testa ottone
- Pistoni in acciaio inox temperato
- Valvola di sicurezza automatica con azzeramento della pressione nella testa pompa
- Accoppiamento diretto pompa/motore a scoppio
- Aspirazione acqua da serbatoio con funzione autoadescente
- 3 Axial stainless steel pistons wobble-plate pump with brass head
- Tempered stainless steel pistons
- Automatic by-pass valve with pump head pressure discharge
- Direct coupling pump with gasoline motor
- Inlet water suction from tank by self priming function



## SRMV

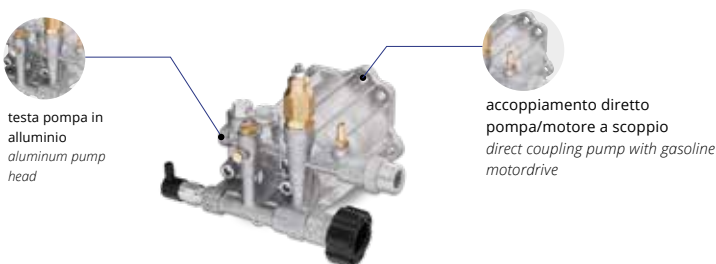

- Pompa a 3 pistoni assiali comandati dal piattello oscillante, testa alluminio
- Pistoni in acciaio inox temperato
- Valvola di sicurezza automatica con azzeramento della pressione nella testa pompa
- Accoppiamento diretto pompa/motore a scoppio
- Aspirazione acqua da serbatoio con funzione autoadescente
- 3 Axial stainless steel pistons wobble-plate pump with aluminum head
- Tempered stainless steel pistons
- Automatic by-pass valve with pump head pressure discharge
- Direct coupling pump with gasoline motor
- Inlet water suction from tank by self priming function





## RCV



testa pompa in ottone  
brass pump head



accoppiamento diretto pompa/motore a scoppio  
direct coupling pump with gasoline motordrive



- Pompa a 3 pistoni in ceramica con sistema biella-manovella, testa pompa in ottone
- Pistoni in acciaio inox temperato
- Valvola di sicurezza automatica con azzeramento della pressione nella testa pompa
- Accoppiamento diretto pompa/motore a scoppio
- Aspirazione acqua da serbatoio con funzione autoadescente
- *Triplex pump with ceramic pistons and connecting rod system with brass pump head*
- *Tempered stainless steel pistons*
- *Automatic by-pass valve with pump head pressure discharge*
- *Direct coupling pump with gasoline motor*
- *Inlet water suction from tank by self priming function*



## RRV



testa pompa in ottone  
brass pump head



accoppiamento diretto pompa/motore a scoppio  
direct coupling pump with gasoline motordrive



- Pompa a 3 pistoni in ceramica con sistema biella-manovella, testa pompa in ottone
- Pistoni in acciaio inox temperato
- Valvola di bypass automatica con azzeramento della pressione nella testa pompa
- Accoppiamento diretto pompa/motore a scoppio
- Aspirazione acqua da serbatoio con funzione autoadescente
- *Triplex pump with ceramic pistons and connecting rod system with brass pump head*
- *Tempered stainless steel pistons*
- *Automatic by-pass valve with pump head pressure discharge*
- *Direct coupling pump with gasoline motor*
- *Inlet water suction from tank by self priming function*

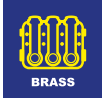

## RKA+CR



testa pompa in ottone nichelato  
nichel plated brass pump head



accoppiamento pompa/motore a scoppio con riduttore di giri  
coupling pump/gasoline motor by gear box drive



- Pompa a 3 pistoni in ceramica con sistema biella-manovella, testa ottone nichelato
- Pistoni in acciaio inox temperato
- Valvola di sicurezza automatica con azzeramento della pressione nella testa pompa
- Accoppiamento pompa/motore a scoppio con riduttore di giri
- Aspirazione acqua da serbatoio con funzione autoadescente
- *Triplex pump with ceramic pistons and connecting rod system with nichel plated brass head*
- *Tempered stainless steel pistons*
- *Automatic by-pass valve with pump head pressure discharge*
- *Coupling pump/gasoline motor by gear box drive*
- *Inlet water suction from tank by self priming function*





## POMPE / PUMPS



	HRM-O	HJRS-A	HPV-O	HJRS-O	HRS	HRC	HRR	HRK	HRW
589	●								
591	●								
7.0	●								
611		●							
613			●						
614			●						
613K			●						
614K			●						
630						●			
630K						●			
670				●					
671				●					
680				●					
680K				●					
780					●				
787					●				
930						●			
960						●			
980							●		
1003						●			
1003XE						●			
1005							●		
1006XE						●			
1007							●		
1007XE							●		
1009								●	
1015							●		
1018									●
1018H									
1120									
1415									
1425									
1435									
1440									
1445									
1445XE									
1447									
1450									
1460									
1475									
1475XE									
1480									
1490									





# 5 Series 589

IDROPULTRICI ALTA PRESSIONE  
high pressure washers

## OLIGHTPRO

TRADE  
SELECTION



### Caratteristiche Generali

- Carrello a due ruote completo di manico ed avvolgitubo
- Pompa a 3 pistoni assiali comandati dal piattello oscillante
- Pistoni in acciaio inox temperato
- Valvola di sicurezza automatica con azzeramento della pressione nella testa pompa
- Manometro
- Motore elettrico monofase ad induzione con protezione termica
- Regolazione della pressione
- Ugello rotante
- Tubo rinforzato con treccia in acciaio (10 m)

### General Features

- Two-wheel trolley with handle and hose reel
- 3 Axial stainless steel pistons wobble-plate pump
- Tempered stainless steel pistons
- Automatic by-pass valve with pump head pressure discharge
- Pressure gauge
- Single-phase induction motor with thermal protector
- Pressure adjustment
- Rotary nozzle
- Steel braided hose (10 m)



MOD	COD	MAX	MAX		NET					
		bar max	psi max	l/h max	gph max	kW	rpm	Hz	V	kg
589	14989	170	2465	500	132	2,5	2800	50	220-240~	24,4

### Accessori standard Standard accessories





### OLIGHTPRO



**TRADE SELECTION**

### Caratteristiche Generali

- Carrello a due ruote completo di manico ed avvolgitubo
- Pompa a 3 pistoni assiali comandati dal piattello oscillante
- Pistoni in acciaio inox temperato
- Valvola di sicurezza automatica con azzeramento della pressione nella testa pompa
- Manometro
- Motore elettrico monofase ad induzione con protezione termica
- Regolazione della pressione
- Ugello rotante
- Tubo rinforzato con treccia in acciaio (10 m)

### General Features

- Two-wheel trolley with handle and hose reel
- 3 Axial stainless steel pistons wobble-plate pump
- Tempered stainless steel pistons
- Automatic by-pass valve with pump head pressure discharge
- Pressure gauge
- Single-phase induction motor with thermal protector
- Pressure adjustment
- Rotary nozzle
- Steel braided hose (10 m)

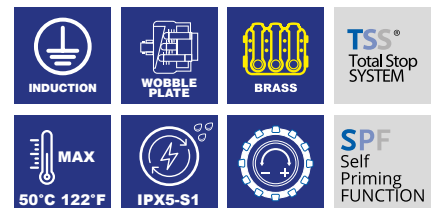

MOD	COD	MAX	MAX		NET					
		bar max	psi max	l/h max	gph max	kW	rpm	Hz	V	kg
591	14990	180	2600	600	159	2,8	2800	50	220-240~	25

### Accessori standard Standard accessories



46575

46577

46578

46580

46581  
(10 m)



# DUALPOWER SYSTEM

## PERFORM & CONTROL



DPS è l'innovativo sistema tecnologico che consente di modulare la performance della idropulitrice attraverso l'utilizzo di una comoda e semplice regolazione integrata sulla pistola.

Ruotando il regolatore verso la modalità HARD si utilizza progressivamente tutta la potenza dell'idropulitrice per affrontare i lavori più gravosi e impegnativi; ruotando verso la modalità SOFT si riduce la potenza del getto in modo da garantire un lavaggio più delicato delle superfici.

Seleziona HARD quando devi eliminare macchie e sporco ostinato da pavimentazione di pietra o cemento, rivestimenti e muri di mattoni, attrezzature da costruzione ed automezzi.

Seleziona SOFT per un livello di lavaggio leggero particolarmente indicato per la pulizia di biciclette, moto e auto e adatto anche a staccionate, mobili da giardino e tende da sole.

*DPS is an innovative technological system that allows you to vary the high pressure washer's performance using a comfortable and easy regulation feature integrated in the trigger gun. By moving the regulation to HARD, you progressively use all the high pressure washer's power for dealing with the toughest cleaning jobs. By setting the regulation to SOFT you decrease the pressure to guarantee a more delicate washing effect. Select HARD for removing tough dirt from paving stones or cement surfaces, wall cladding and brick walls, construction equipment and muddy vans and vehicles. Select SOFT for more delicate cleaning effect, such as cleaning bicycles, cars and motorbikes, garden fencing, garden furniture and sun shades.*





### ○ LIGHTPRO

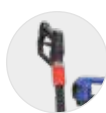

pistola con regolatore di pressione  
*trigger gun with pressure regulator*



schiumogeno alta pressione  
*high pressure foam lance*



lancia in metallo con attacco rapido  
*metal lance with quick connection*



doppio ugello rotante PRO  
*twin rotary nozzle PRO*



manico telescopico con ganci per appoggio pistola  
*telescopic handle with gun parking hooks*



avvolgitubo in pressione con tubo 10 m  
*In-pressure hose reel with hose 10 m*



porta-accessori integrato  
*built-in accessory holders*



filtro ingresso acqua ispezionabile e manometro  
*inspectable water intake filter and pressure gauge*



### Caratteristiche Generali

- Pistola con regolatore di pressione
- Carrello a due ruote completo di manico ed avvolgitubo
- Pompa a 3 pistoni assiali comandati dal piattello oscillante
- Pistoni in acciaio inox temperato
- Valvola di sicurezza automatica con azzeramento della pressione nella testa pompa
- Manometro
- Motore elettrico monofase a induzione con protezione termica
- Doppio ugello rotante PRO
- Tubo rinforzato con treccia in acciaio (10 m)

### General Features

- Trigger gun with pressure regulator
- Two-wheel trolley with handle and hose reel
- 3 Axial stainless steel pistons wobble-plate pump
- Tempered stainless steel pistons
- Automatic by-pass valve with pump head pressure discharge
- Pressure gauge
- Single-phase induction motor with thermal protector
- Twin Nozzle PRO
- Steel braided hose (10 m)

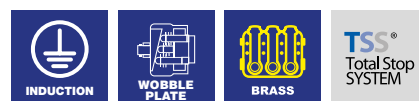

MOD	COD	MAX	MAX		NET					
		bar max	psi max	l/h max	gph max	kW	rpm	Hz	V	kg
7.0	15343	160	2300	700	185	2,8	2800	50	220-230~	26,2

### Accessori standard Standard accessories

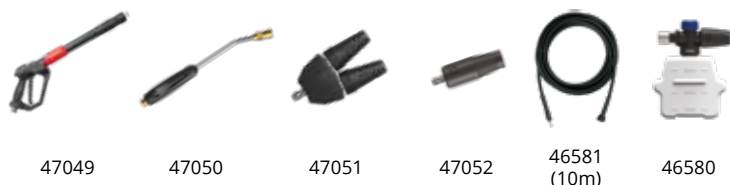

47049

47050

47051

47052

46581  
(10m)

46580

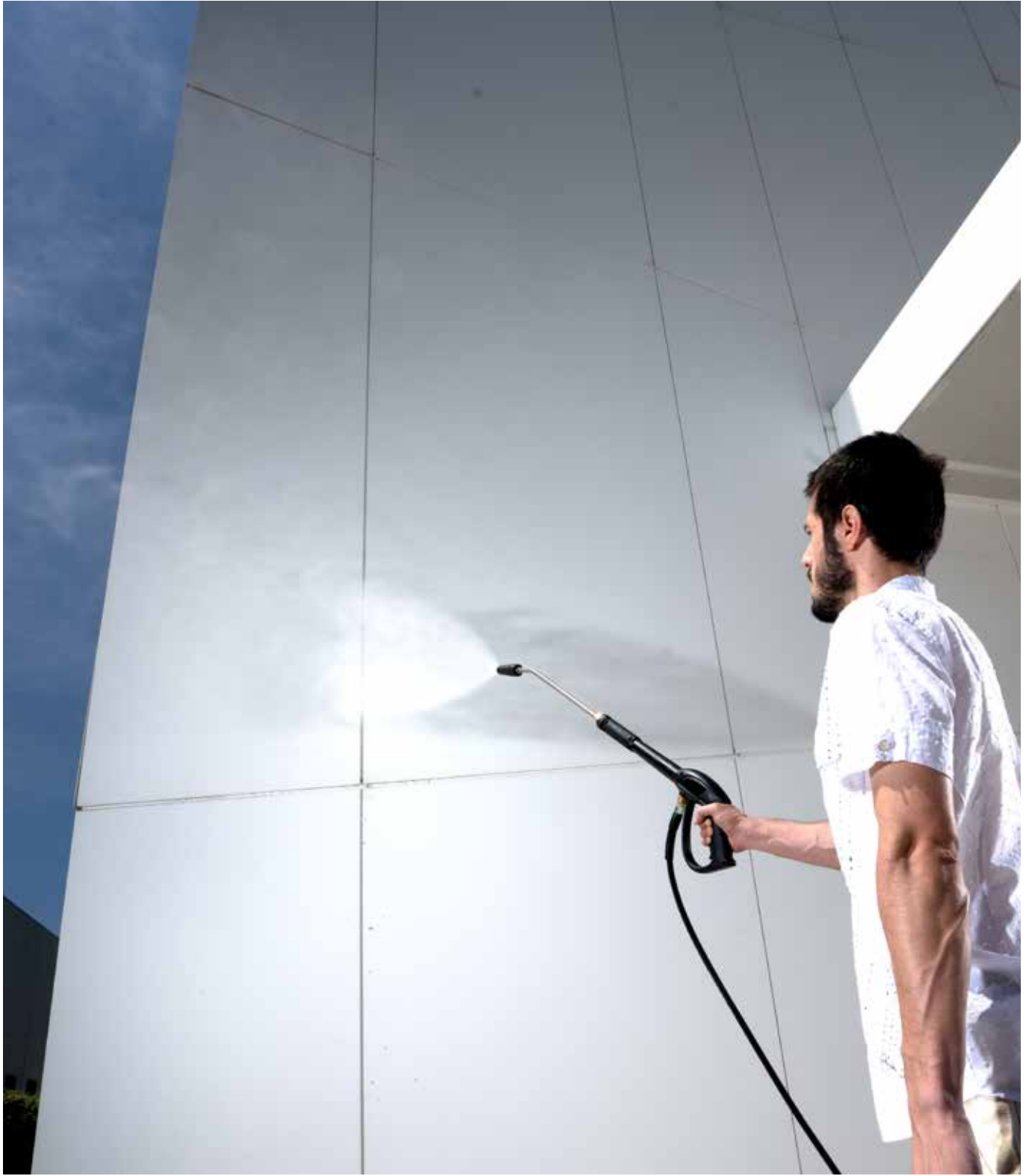

## OLIGHTPRO



**TRADE SELECTION**

### Caratteristiche Generali

- Pompa a 3 pistoni in acciaio inox temprato con sistema biella-manovella
- Valvola di sicurezza automatica con azzeramento della pressione nella testa pompa
- Motore elettrico monofase a induzione con protezione termica
- Regolazione della pressione
- Manometro
- Funzione autoadescante
- Tubo rinforzato con treccia in acciaio (8 m)

### General Features

- Triplex pump with tempered stainless steel pistons and connecting rod system
- Automatic by-pass valve with pump head
- pressure discharge
- Single-phase induction motor with thermal protection
- Pressure adjustment
- Pressure gauge
- Self-priming function
- Steel braided hose (8 m)



MOD	COD	MAX	MAX		NET					
		bar max	psi max	l/h max	gph max	kW	rpm	Hz	V	kg
611	15167	140	2030	500	132	2,1	2800	50	220-240~	20,1

### Accessori standard Standard accessories

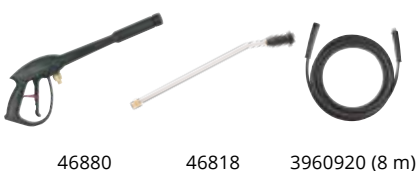



# 6 Series 613.614

IDROPULTRICI ALTA PRESSIONE  
high pressure washers

## OLIGHTPRO

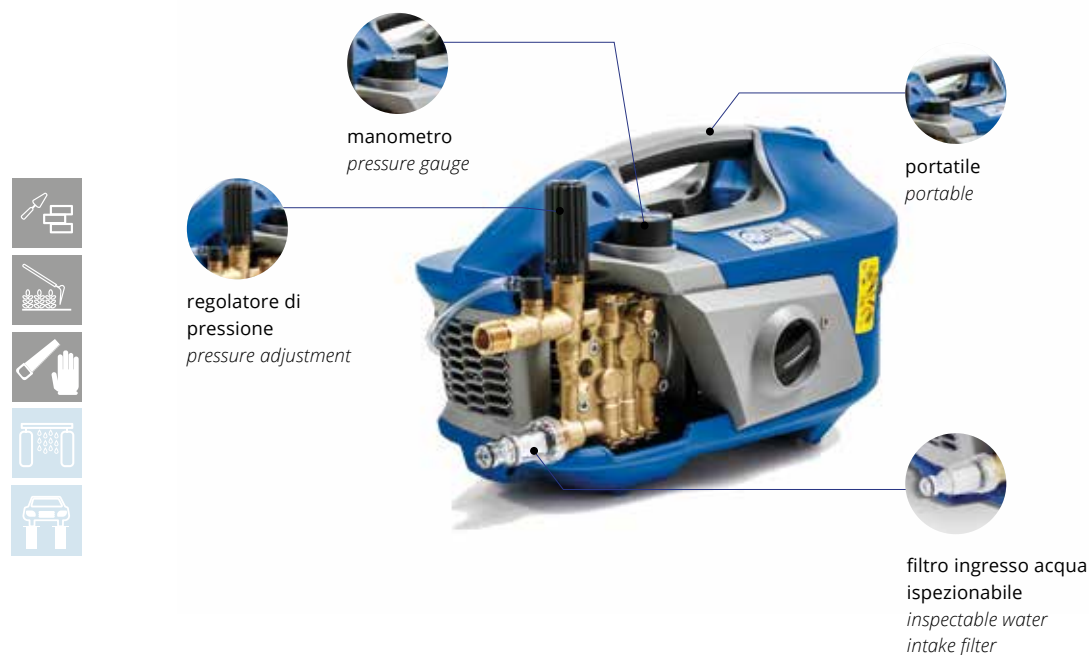

### Caratteristiche Generali

- Pompa a 3 pistoni in ceramica con sistema biella-manovella
- Valvola di sicurezza automatica con azzeramento della pressione nella testa pompa
- Motore elettrico monofase a induzione con protezione termica
- Regolazione della pressione
- Manometro
- Aspirazione detergente incorporata
- Funzione autoadescente
- Tubo rinforzato con treccia in acciaio (8 m)

### General Features

- Triplex pump with ceramic pistons and connecting rod system
- Automatic by-pass valve with pump head
- pressure discharge
- Single-phase induction motor with thermal protection
- Pressure adjustment
- Pressure gauge
- Built-in detergent suction
- Self-priming function
- Steel braided hose (8 m)



MOD	COD	MAX	MAX		NET					
		bar max	psi max	l/h max	gph max	kW	rpm	Hz	V	kg
613	13975	150	2175	500	132	2,5	2800	50	220-240~	16,8
614	13977	160	2320	510	135	2,9	2800	50	220-240~	18,4

### Accessori standard Standard accessories





# 6 Series 613K.614K

IDROPULTRICI ALTA PRESSIONE  
high pressure washers



## OLIGHTPRO



### Caratteristiche Generali

- Carrello a 2 ruote completo di manico
- Pompa a 3 pistoni in ceramica con sistema biella-manovella
- Valvola di sicurezza automatica con azzeramento della pressione nella testa pompa
- Motore elettrico monofase a induzione con protezione termica
- Regolazione della pressione
- Manometro
- Aspirazione detergente incorporata
- Funzione autoadescante
- Tubo rinforzato con treccia in acciaio (10 m)

### General Features

- Two-wheel trolley with handle
- Triplex pump with ceramic pistons and connecting rod system
- Automatic by-pass valve with pump head
- pressure discharge
- Single-phase induction motor with thermal protection
- Pressure adjustment
- Pressure gauge
- Built-in detergent suction
- Self-priming function
- Steel braided hose (10 m)



MOD	COD	MAX	MAX		NET					
		bar max	psi max	l/h max	gph max	kW	rpm	Hz	V	kg
613K	13976	150	2175	500	132	2,5	2800	50	220-240~	23
614K	13978	160	2320	510	135	2,9	2800	50	220-240~	24,6

### Accessori standard Standard accessories



43471      43472 (613K)      3780441 (10 m)  
41806 (614K)





# 6 Series 670.671

IDROPULTRICI ALTA PRESSIONE  
high pressure washers

## OLIGHTPRO



### Caratteristiche Generali

- Pompa a 3 pistoni in ceramica con sistema biella-manovella
- Valvola di sicurezza automatica con azzeramento della pressione nella testa pompa
- Motore elettrico monofase a induzione con protezione termica
- Regolazione della pressione
- Manometro
- Aspirazione detergente incorporata
- Funzione autoadescante
- Tubo rinforzato con treccia in acciaio (8 m)

### General Features

- Triplex pump with ceramic pistons and connecting rod system
- Automatic by-pass valve with pump head pressure discharge
- Single-phase induction motor with thermal protection
- Pressure adjustment
- Pressure gauge
- Built-in detergent suction
- Self-priming function
- Steel braided hose (8 m)



MOD	COD	MAX	MAX		NET					
		bar max	psi max	l/h max	gph max	kW	rpm	Hz	V	kg
670	14680	160	2320	500	132	2,5	2800	50	220-240~	20
671	14697	180	2610	510	135	2,9	2800	50	220-240~	23,6

### Accessori standard Standard accessories



## OLIGHTPRO

**TRADE SELECTION**



### Caratteristiche Generali

- Pompa a 3 pistoni in ceramica con sistema biella-manovella
- Valvola di sicurezza automatica con azzeramento della pressione nella testa pompa
- Motore elettrico monofase a induzione con protezione termica
- Regolazione della pressione
- Manometro
- Funzione autoadescente
- Tubo rinforzato con treccia in acciaio (8 m)

### General Features

- Triplex pump with ceramic pistons and connecting rod system
- Automatic by-pass valve with pump head pressure discharge
- Single-phase induction motor with thermal protection
- Pressure adjustment
- Pressure gauge
- Self-priming function
- Steel braided hose (8 m)



MOD	COD	MAX	MAX		NET					
		bar max	psi max	l/h max	gph max	kW	rpm	Hz	V	kg
680	15267	150	2175	600	160	2,6	2800	50	220-240~	20,8
680K	15268	150	2175	600	160	2,6	2800	50	220-240~	25,3

### Accessori standard Standard accessories





# NEW 6 Series 630

# DUAL PRO APPLIANCE SYSTEM



DPA è l'innovativo sistema tecnologico che permette di selezionare la modalità di funzionamento dell'idropulitrice agendo sul selettore di accensione a tre posizioni: **OFF / I / B.**

*DPA is the innovative technological system that allows to select the operating mode of the high pressure washer by acting on the three position switch: **OFF / I / B.***



#### THE POWER OF CLEANING

Il nuovo modello 630 AR Blue Clean, equipaggiato con l'innovativo sistema tecnologico DPA, appartiene alla gamma di macchine professionali. Pensata per l'utilizzatore privato esigente o per il professionista che intende svolgere lavori di rimozione di sporco pesante, è ideale per lavare l'auto, le varie zone ed oggetti dell'esterno casa e adatta per la manutenzione di camion e macchine agricole.

#### THE POWER OF CLEANING

*The new model 630 AR Blue Clean, equipped with the technological DPA system, belongs to the range of professional machines. Created for the demanding of private user or for the professional who wants to carry out heavy dirt removal work, it is ideal for washing cars, the various areas and objects outside of the house and suitable for the maintenance of trucks and agricultural machinery.*

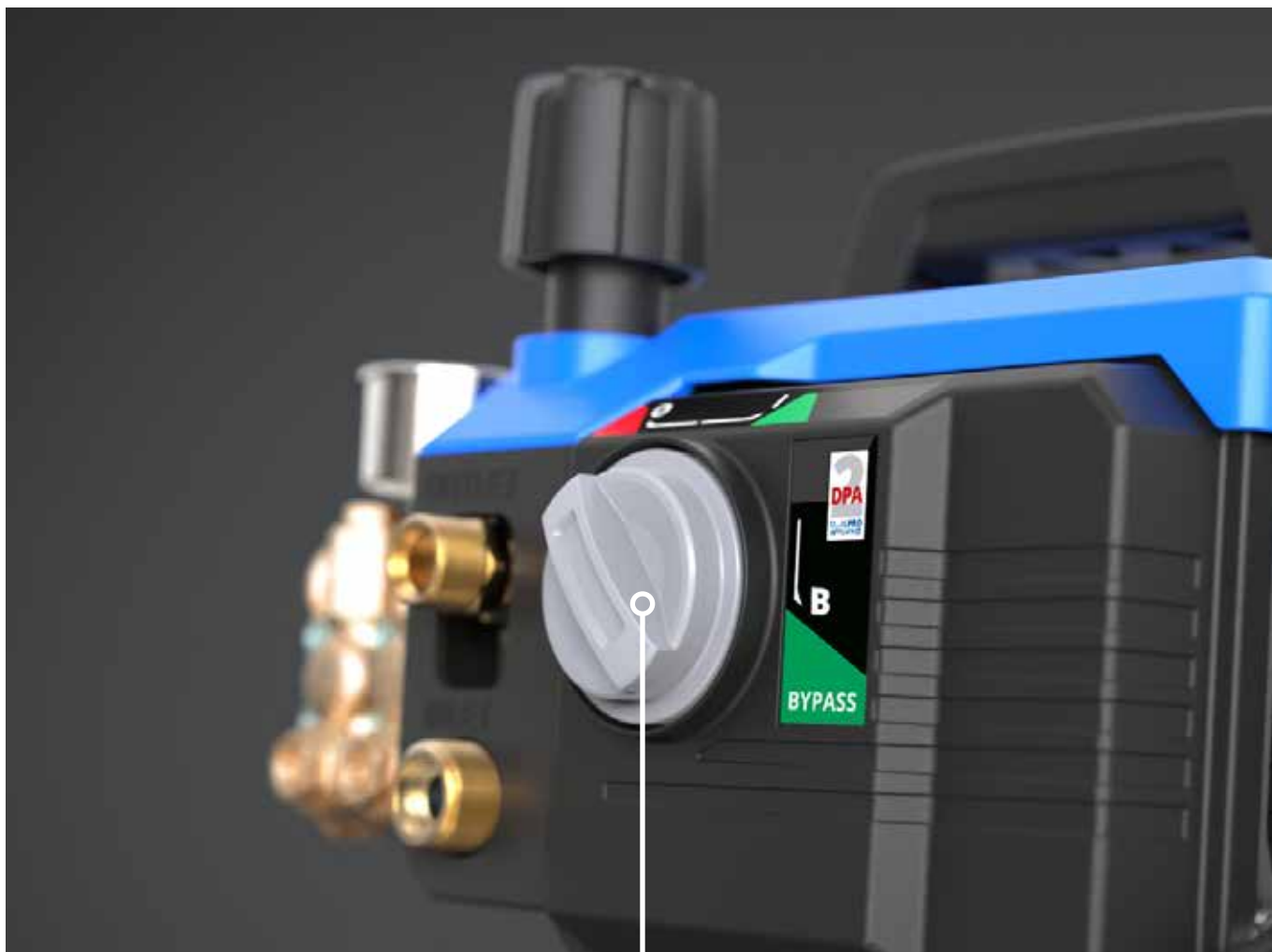

La nuova idropulitrice 630 è dotata di un selettore a tre posizioni: OFF / TSS / BY-PASS.

*The new 630 high pressure washer is equipped with a three-position switch: OFF / TSS / BY-PASS.*

## I-TOTAL STOP SYSTEM

Particolarmente indicato durante il normale utilizzo dell'idropulitrice permette l'arresto immediato della stessa quando viene rilasciata la pistola. Questo sistema garantisce minori consumi energetici e diminuisce l'usura di pompa e motore.

*Particularly suitable during the normal use of the pressure washer and allows the immediate stop of the same when the gun is released. This system guarantees lower energy consumption and reduces the wear of the pump and motor.*

## B-BY-PASS SYSTEM

Il sistema by-pass è indicato per condizioni di uso intensivo in cui l'idropulitrice è soggetta a frequenti arresti e ripartenze o se viene utilizzata in condizioni ambientali gravose (es. alte temperature, alta umidità ambientale, ambiente con bassa circolazione di aria).

*The by-pass system is suitable for intensive use conditions in which the pressure washer is subject to frequent stops and restarts or if it is used in harsh environmental conditions (e.g. high temperatures, high ambient humidity, environment with low air circulation).*





# 6 Series 630

IDROPULTRICI ALTA PRESSIONE  
high pressure washers

## HEAVYPRO



Blue Clean Factor



DUALPRO APPLIANCE



### Caratteristiche Generali

- Pompa a 3 pistoni in ceramica con sistema biella-manovella
- Valvola di sicurezza automatica con azzeramento della pressione nella testa pompa
- Motore elettrico monofase a induzione con protezione termica
- Regolazione della pressione
- Manometro
- Kit aspirazione detergente
- Opzione by-pass
- Pistola con swivel
- Funzione autoadescante
- Tubo rinforzato con treccia in acciaio (10 m)

### General Features

- Triplex pump with ceramic pistons and connecting rod system
- Automatic by-pass valve with pump head pressure discharge
- Single-phase induction motor with thermal protection
- Pressure adjustment
- Pressure gauge
- Detergent suction kit
- By-pass option
- Gun with swivel
- Self-priming function
- Steel braided hose (10 m)

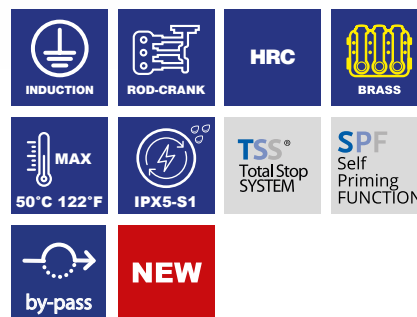

MOD	COD	MAX		MAX		MAX		MAX		MAX		MAX		kg NET
		bar max	bar work	psi max	psi work	l/h work	gph work	hp	kW	kW work	rpm	Hz	V	kg
630	15512	150	120	2175	1740	600	159	2,7	2,0	2,6	1450	50	220-240~	27

### Accessori standard Standard accessories



# 6 Series 630K

IDROPULTRICI ALTA PRESSIONE  
high pressure washers



## HEAVYPRO



porta accessori  
built-in accessories  
holder



telaio in acciaio  
verniciato  
painted steel frame



regolatore della  
pressione  
pressure adjustment



manometro  
pressure gauge



livello olio  
oil level



selettore rotativo a tre posizioni  
OFF/TSS/by-pass  
3 positions rotative switch  
OFF/TSS/by-pass



battistrada in  
gomma  
rubber wheels



### Caratteristiche Generali

- Carrello a 2 ruote completo di manico
- Pompa a 3 pistoni in ceramica con sistema biella-manovella
- Valvola di sicurezza automatica con azzeramento della pressione nella testa pompa
- Motore elettrico monofase a induzione con protezione termica
- Regolazione della pressione
- Manometro
- Kit aspirazione detergente
- Opzione by-pass
- Pistola con swivel
- Funzione autoadescante
- Tubo rinforzato con treccia in acciaio (10 m)

### General Features

- Two-wheel trolley with handle
- Triplex pump with ceramic pistons and connecting rod system
- Automatic by-pass valve with pump head
- pressure discharge
- Single-phase induction motor with thermal protection
- Pressure adjustment
- Pressure gauge
- Detergent suction kit
- By-pass option
- Gun with swivel
- Self-priming function
- Steel braided hose (10 m)



MOD	COD	MAX		MAX		MAX		MAX		MAX		MAX		NET
		bar	bar	psi	psi	l/h	gph	hp	kW	kW	rpm	Hz	V	kg
		max	work	max	work	work	work			work				
630K	15589	150	120	2175	1740	600	159	2,7	2,0	2,6	1450	50	220-240~	34,5

### Accessori standard Standard accessories



Kit avvolgitubo senza tubo  
Hose reel without hose

Unità di montaggio a muro  
senza tubo  
Wall mounted kit without hose



# NEW 6 Series 630

IDROPULTRICI ALTA PRESSIONE  
*high pressure washers*

- **PORTATILE**  
PORTABLE
- **DESIGN ERGONOMICO**  
ERGONOMIC DESIGN
- **POTENTE E COMPATTA**  
POWERFUL AND COMPACT



# NEW 6 Series 630

## UNIQUE DETAILS

- 1** PORTA-ACCESSORI INTEGRATO  
*Built-in accessories holder*
- 2** MANOMETRO INTEGRATO  
*Integrated pressure gauge*
- 3** REGOLATORE DI PRESSIONE  
*Pressure adjustment*
- 4** SELETORE BY-PASS/TSS  
*By-pass/TSS Switch*
- 5** COMPATTA  
*Compact*

## 3 DIVERSE CONFIGURAZIONI: STAND-ALONE, CON KIT CARRELLO E WALL-MOUNTED.

*3 different setups: stand alone, kart and wall-mounted*

## WALL MOUNTED & KART UNIT FOR ALL 6 SERIES MODELS

- 1** UNITÀ DI MONTAGGIO A MURO  
*Wall mounted kit*
- 2** KIT AVVOLGITUBO A MURO  
*Wall mounted hose reel*
- 3** TUBO AD ALTA PRESSIONE DI 15M  
*HP 15mt hose.*
- 4** PULSANTE DI SGANCIO RAPIDO  
*Easy unlock button*
- 5** RUOTE AD ALTA STABILITÀ  
*High stability wheels*
- 6** KIT CARRELLO CON TELAIO  
PIEGHEVOLE IN ACCIAIO VERNICIATO  
*Trolley kit with foldable painted steel frame*
- 7** PORTA ACCESSORI INTEGRATO  
*Built-in accessory holder*



### UNITÀ DI MONTAGGIO A MURO

Kit avvolgitubo a muro con tubo ad alta pressione di 15m.

### WALL MOUNTED UNIT

Wall mounted hose reel with HP hose 15m hose.

### KIT CARRELLO

Telaio pieghevole in acciaio verniciato con grandi ruote durature di  $\varnothing 250\text{mm}$  per un migliore bilanciamento.

### TROLLEY KIT

Foldable painted steel frame with durable rubber wheels  $\varnothing 250\text{mm}$  for perfect balancing.



# 7 Series 780

IDROPULTRICI ALTA PRESSIONE  
high pressure washers

## HEAVYPRO



### Caratteristiche Generali

- Funzionamento orizzontale
- Carrello a due ruote completo di manico
- Pompa a 3 pistoni in ceramica, con sistema biella-manovella
- Valvola di sicurezza automatica con azzeramento della pressione nella testa pompa
- Motore elettrico monofase con protezione termica
- Regolazione della pressione
- Manometro
- Aspirazione detergente incorporata
- Aspirazione detergente regolabile
- Capacità del serbatoio detergente 2l
- Funzione autoadescante
- Tubo rinforzato con treccia in acciaio (10 m)

### General Features

- Horizontal working
- Two-wheel trolley with handle
- Triplex pump with ceramic pistons and connecting rod system
- Automatic safety valve with pressure shut-off at pump head
- Single-phase heavy duty motor with thermal protector
- Pressure adjustment
- Pressure gauge
- Built-in detergent suction
- Adjustable detergent injector
- Detergent tank capacity 2l
- Self-priming function
- Steel braided hose (10 m)

 INDUCTION	 ROD-CRANK	 HRS	 BRASS
 MAX 60°C 140°F	 IPX5-S1	 TSS® Total Stop SYSTEM	 SPF Self Priming FUNCTION
<b>NEW</b>			

MOD	COD	 MAX				 MAX								 NET
		bar max	bar work	psi max	psi work	l/h work	gph work	hp	kW	kW work	rpm	Hz	V	kg
780	22341-V	150	120	2175	1740	630	166	3	2,2	3	1450	50	230~	41,5

### Accessori standard Standard accessories







### HEAVYPRO



manometro  
pressure gauge

manico ergonomico  
ergonomic handle

porta accessori  
built-in accessories holder

serbatoio detergente integrato  
built-in detergent tank

battistrada in gomma  
rubber wheels

regolatore della pressione  
pressure regulator

### Caratteristiche Generali

- Funzionamento orizzontale
- Carrello a due ruote completo di manico
- Pompa a 3 pistoni in ceramica, con sistema biella-manovella
- Valvola di sicurezza automatica con azzeramento della pressione nella testa pompa
- Motore elettrico trifase con protezione termica
- Regolazione della pressione
- Manometro
- Aspirazione detergente incorporata
- Aspirazione detergente regolabile
- Capacità del serbatoio detergente 2l
- Funzione autoadescante
- Tubo rinforzato con treccia in acciaio (10 m)

### General Features

- Horizontal working
- Two-wheel trolley with handle
- Triplex pump with ceramic pistons and connecting rod system
- Automatic safety valve with pressure shut-off at pump head
- Three-phase heavy duty motor with thermal protector
- Pressure adjustment
- Pressure gauge
- Built-in detergent suction
- Adjustable detergent injector
- Detergent tank capacity 2l
- Self-priming function
- Steel braided hose (10 m)

INDUCTION	ROD-CRANK	HRS	BRASS
MAX 60°C 140°F	IPX5-S1	TSS® Total Stop SYSTEM	SPF Self Priming FUNCTION
<b>NEW</b>			

MOD	COD	MAX		MAX								NET		
		bar max	bar work	psi max	psi work	l/h work	gph work	hp	kW	kW work	rpm	Hz	V	kg
787	22320-V	180	150	2610	2175	900	238	5,5	4	5	1450	50	400 3~	43

### Accessori standard Standard accessories



**TST**<sup>®</sup>  
Total Stop  
SYSTEM  
TIMED



*Nata a Modena*

Born in Modena

## 9 SERIES

La nuova Serie 9 è il match perfetto tra design e prestazioni professionali. Nata a Modena, negli stabilimenti dedicati al cleaning, quest'idropultrice ad acqua fredda ha delle dimensioni compatte e vanta un'estrema manovrabilità, che la rendono al tempo stesso robusta e maneggevole. L'impugnatura del manico è stata progettata per facilitarne l'utilizzo, come anche i diversi punti di rimessaggio accessori sulla macchina. Il pratico porta lancia, sul fianco della macchina ed il gancio per il tubo alta pressione nella parte posteriore. Si tratta di una gamma di idropultrici con dotazione completa e professionale, equipaggiate con accessori ideali per utilizzi continuativi e complessi.

## 9 SERIES

*The new Series 9 is the perfect match of design and professional performance. Created in Modena, in the plants that specialise in cleaning equipment, this cold water high pressure washer is compact in size and very manoeuvrable, making it both sturdy and agile. The handle grip is styled for user-friendliness, as are the various accessory stowing points on the appliance. These include the handy lance holder on the side of the appliance and the high pressure hose hook at the rear. It is a high pressure washer range with a full, professional outfit, equipped with the ideal accessories for continuous use on complex jobs.*

## UNIQUE DETAILS

- 1** MANUBRIO ERGONOMICO  
*Ergonomic handle*
- 2** PORTA ACCESSORI INTEGRATI  
*Built-in accessories holders*
- 3** RUOTE AD ALTA STABILITÀ  
*High stability wheels ø 35 cm*
- 4** PRESSIONE REGOLABILE  
*Pressure adjustment*
- 5** MANOMETRO  
*Pressure gauge*
- 6** FILTRO ACQUA ISPEZIONALE  
*Inspectable water filter*

### THE POWER OF CLEANING

Grazie all'elevata pressione ed alle notevoli portate, le idropultrici della SERIE 9, riescono a rimuovere con estrema facilità lo sporco più ostinato ed incrostato dalle grandi superfici. Le prestazioni di queste idropultrici sono state studiate per soddisfare al meglio questo genere di esigenze, specialmente nel settore edile ed automotive.

### THE POWER OF CLEANING

*Thanks to their high pressures and flow rates, SERIES 9 high pressure washers can remove the most stubborn, firmly encrusted dirt from large surfaces. These high pressure washers have performance levels designed to tackle needs of this kind with the greatest success, especially in the construction and automotive sectors.*





# 9 Series 930.960.980

IDROPULTRICI ALTA PRESSIONE  
high pressure washers

## HEAVYPRO



### Caratteristiche Generali

- Carrello a due ruote completo di manico
- Pompa a 3 pistoni in ceramica, con sistema biella-manovella
- Valvola di bypass automatica con azzeramento della pressione nella testa pompa
- Motore elettrico monofase a induzione con protezione termica
- Regolazione della pressione
- Manometro
- Aspirazione detergente incorporata
- Aspirazione detergente regolabile
- Funzione autoadescante
- Tubo rinforzato con treccia in acciaio (10 m)

### General Features

- Two-wheel trolley unit with handle
- Triplex pump with ceramic pistons and connecting rod system
- Automatic bypass valve with pressure shut-off at pump head
- Single-phase induction motor with thermal protection
- Pressure adjustment
- Pressure gauge
- Built-in detergent suction
- Adjustable detergent injector
- Self-priming function
- Steel braided hose (10 m)

930	960	980
<b>HRC</b>	<b>HRC</b>	<b>HRR</b>
<b>INDUCTION</b>	<b>ROD-CRANK</b>	<b>BRASS</b>
<b>60°C 140°F</b>	<b>IPX5-S1</b>	<b>SPF Self Priming FUNCTION</b>
	<b>TSS Total Stop SYSTEM</b>	<b>TST Total Stop SYSTEM TIMED</b>
	930.960	980

MOD	COD	MAX		MAX										KG NET
		bar max	bar work	psi max	psi work	l/h work	gph work	hp	kW	kW work	rpm	Hz	V	kg
<b>930</b>	<b>14261</b>	150	120	2175	1740	630	166	3	2,2	3	1450	50	230~	43,6
<b>960</b>	<b>15479</b>	200	180	2900	2610	840	221	6,1	4,5	5	1450	50	400 3~	45,5
<b>980</b>	<b>15480</b>	230	200	3335	2900	900	238	7,5	5,5	7,4	1450	50	400 3~	52,2

### Accessori standard Standard accessories





### HEAVYPRO



mod. 1003

### Caratteristiche Generali

- Carrello robusto in metallo a due ruote completo di manico
- Pompa a 3 pistoni in ceramica, con sistema biella-manovella
- Valvola di by-pass automatica con azzeramento della pressione nella testa della pompa
- Motore elettrico a induzione monofase con protezione termica
- Regolazione della pressione
- Manometro
- Serbatoio detergente integrato (3 l) con aspirazione regolabile
- Tubo rinforzato con treccia in acciaio (10 m)
- Funzione autoadescente
- Pistola con swivel (1005-1007)

### General Features

- Heavy-duty two wheeled trolley with handle
- Triplex pump with ceramic pistons and connecting rod system
- Automatic by-pass valve with pressure with pump head pressure discharge
- Single-phase induction motor with thermal protector
- Pressure adjustment
- Pressure gauge
- Built-in detergent tank (3 l) with adjustable detergent injector
- Steel braided hose (10 m)
- Self-priming function
- Gun with swivel (1005-1007)

		<b>HRC</b>	<b>HRR</b>
			<b>SPF</b> Self Priming FUNCTION
		<b>NEW</b>	

MOD	COD	MAX				MAX				1007				KG NET
		bar max	bar work	psi max	psi work	l/h work	gph work	hp	kW	kW work	rpm	Hz	V	
1003	24385-V	150	120	2175	1740	630	166	3	2,2	3	1450	50	230~	40,6
1003 RLW*	24389-V	150	120	2175	1740	630	166	3	2,2	3	1450	50	230~	53
1005	15602	180	150	2610	2175	900	238	6,1	4,5	5	1450	50	400 3~	43
1007	15477-V	230	200	3335	2900	900	238	7,5	5,5	7,4	1450	50	400 3~	54,8
1007 RLW*	15478-V	230	200	3335	2900	900	238	7,5	5,5	7,4	1450	50	400 3~	61,6

\*A richiesta

### Accessori standard Standard accessories

1003					1005 - 1007				
47039	3600650	3961050 (10 m) (1003) 3600970 (15 m) (RLW)	3600400 (low p.) 3600350 (0004) 3600360 (1504) 3600370 (2504) 3600380 (4004)		47209	46221	3961050 (10 m) (1005 - 1007) 3600970 (15 m) (1007 RLW)	3083 (1505) - 1005 3086 (15045) - 1007	



## HEAVYPRO

TRADE  
SELECTION



telaio in acciaio verniciato  
painted steel frame



filtro ingresso  
acqua ispezionabile  
inspectable water  
intake filter



porta accessori  
built-in accessories holder



serbatoio detergente  
integrato  
built-in detergent tank



battistrada in  
gomma  
rubber wheels



### Caratteristiche Generali

- Carrello robusto in metallo a due ruote completo di manico
- Pompa a 3 pistoni in ceramica, con sistema biella-manovella
- Valvola di by-pass automatica con azzeramento della pressione nella testa della pompa
- Motore elettrico a induzione monofase con protezione termica
- Regolazione della pressione
- Manometro
- Serbatoio detergente integrato (3 l) con aspirazione regolabile
- Filtro acqua ispezionabile
- Funzione autoadescante
- Tubo rinforzato con treccia in acciaio (10 m)

### General Features

- Heavy-duty two wheeled trolley with handle
- Triplex pump with ceramic pistons and connecting rod system
- Automatic by-pass valve with pressure with pump head pressure discharge
- Single-phase induction motor with thermal protector
- Pressure adjustment
- Pressure gauge
- Built-in detergent tank (3 l) with adjustable detergent injector
- Inspectable water filter
- Self-priming function
- Steel braided hose (10 m)



TST<sup>®</sup>  
Total Stop  
SYSTEM  
TIMED  
1007XE

MOD	COD	MAX		MAX		MAX		MAX		MAX		MAX		kg NET
		bar max	bar work	psi max	psi work	l/h work	gph work	hp	kW	kW work	rpm	Hz	V	
1003 XE	15165	150	120	2175	1740	630	166	3	2,2	3	1450	50	230~	40,6
1006 XE	15475	200	150	2610	2175	840	221	6,1	4,5	5	1450	50	230~	51,9
1007 XE	15476	230	200	3335	2900	900	238	7,5	5,5	7,4	1450	50	400 3~	55,3

### Accessori standard Standard accessories

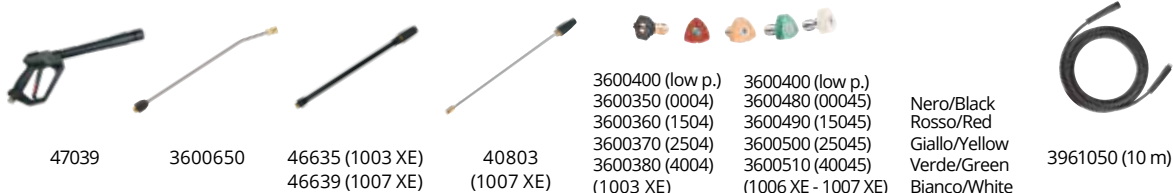

47039

3600650

46635 (1003 XE)  
46639 (1007 XE)

40803  
(1007 XE)

3600400 (low p.)  
3600350 (0004)  
3600360 (1504)  
3600370 (2504)  
3600380 (4004)  
(1003 XE)

3600480 (00045)  
3600490 (15045)  
3600500 (25045)  
3600510 (40045)  
(1006 XE - 1007 XE)

Nero/Black  
Rosso/Red  
Giallo/Yellow  
Verde/Green  
Bianco/White

3961050 (10 m)



### HEAVYPRO



porta accessori  
built-in accessories holder



battistrada in gomma  
rubber wheels



telaio in acciaio verniciato  
painted steel frame



**RLW**

Versione RLW a richiesta  
RLW Version on request  
15m

### Caratteristiche Generali

- Carrello robusto in metallo a due ruote completo di manico ed avvolgitubo in pressione
- Pompa a 3 pistoni in ceramica, con sistema biella-manovella
- Valvola di by-pass automatica con azzeramento della pressione nella testa della pompa
- Motore elettrico a induzione trifase con protezione termica
- Regolazione della pressione
- Manometro
- Valvola di regolazione flangiata (VR)
- Aspirazione detergente
- Tubo rinforzato con treccia in acciaio (10 m)
- Funzione autoadescante
- Pistola con swivel

### General Features

- Heavy-duty two wheeled trolley with handle and in-pressure hose reel
- Triplex pump with ceramic pistons and connecting rod system
- Automatic by-pass valve with pressure with pump head pressure discharge
- Three-phase induction motor with thermal protector
- Pressure adjustment
- Pressure gauge
- Flanged pressure unloader (VR)
- Detergent injector
- Steel braided hose (10 m)
- Self-priming function
- Gun with swivel

INDUCTION	ROD-CRANK	HRK	BRASS
MAX 60°C 140°F	IPX5-S1	TST® Total Stop SYSTEM TIMED	SPF Self Priming FUNCTION

MOD	COD	MAX		MAX		MAX		MAX		MAX		MAX		kg NET
		bar max	bar work	psi max	psi work	l/h work	gph work	hp	kW	kW work	rpm	Hz	V	
1009	15590	230	200	3335	2900	1260	333	9,6	7	9,3	1450	50	400 3~	57
1009 RLW*	15354-V	230	200	3335	2900	1260	333	9,6	7	9,3	1450	50	400 3~	60,7

\*A richiesta

### Accessori standard Standard accessories





# 10 Series 1015

IDROPULTRICI ALTA PRESSIONE  
high pressure washers

## HEAVYPRO



### Caratteristiche Generali

- Struttura robusta con cofano in acciaio inox
- Pompa a 3 pistoni in ceramica con sistema biella- manovella
- Valvola di by-pass automatica con azzeramento della pressione nella testa della pompa
- Motore elettrico trifase
- Valvola di regolazione flangiata (Gymatic 3/B - ID)
- Regolazione pressione
- Aspirazione detergente incorporata
- Tubo rinforzato con treccia in acciaio (10 m)
- Funzione autoadescante
- Pistola con swivel

### General Features

- Heavy-duty frame with stainless steel cover
- Triplex pump with ceramic pistons and connecting rod system
- Automatic by-pass valve with pump head pressure discharge
- Heavy-duty three-phase motor
- Flanged unloader valve (Gymatic 3/B - ID)
- Pressure adjustment
- Built-in detergent suction
- Steel braided hose (10 m)
- Self-priming function
- Gun with swivel

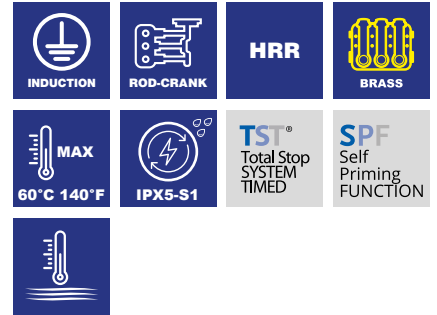

MOD	COD	MAX				MAX								KG NET
		bar max	bar work	psi max	psi work	l/h work	gph work	hp	kW	kW work	rpm	Hz	V	kg
1015	25283-V	230	200	3335	2900	900	238	7,5	5,5	7,4	1450	50	400 3~	60

### Accessori standard Standard accessories



## HEAVYPRO



### Caratteristiche Generali

- Struttura robusta con cofano in acciaio inox
- Pompa a 3 pistoni in ceramica con sistema biella- manovella
- Valvola di by-pass automatica con azzeramento della pressione nella testa della pompa
- Motore elettrico trifase
- Flangia con giunto elastico per accoppiamento pompa-motore
- Valvola di regolazione flangiata
- Regolazione pressione
- Aspirazione detergente incorporata
- Tubo rinforzato con treccia in acciaio (10 m)
- Funzione autoadescente
- Pistola con swivel

### General Features

- Heavy-duty frame with stainless steel cover
- Triplex pump with ceramic pistons and connecting rod system
- Automatic by-pass valve with pump head pressure discharge
- Heavy-duty three-phase motor
- Flange with elastic joint for pump-motor coupling
- Flanged unloader valve
- Pressure adjustment
- Built-in detergent suction
- Steel braided hose (10 m)
- Self-priming function
- Gun with swivel

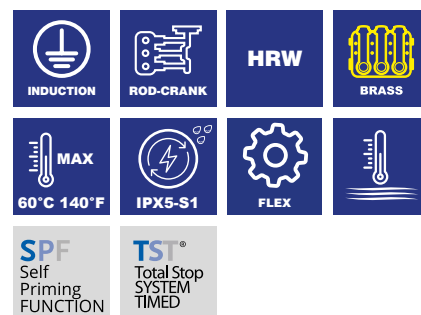

MOD	COD	MAX		MAX		MAX		MAX		MAX		MAX		KG NET
		bar max	bar work	psi max	psi work	l/h work	gph work	hp	kW	kW work	rpm	Hz	V	kg
1018	24491-V	230	200	3335	2900	900	238	7,5	5,5	7,4	1450	50	400 3~	80

### Accessori standard Standard accessories





# 10 Series 1018H

IDROPULTRICI ALTA PRESSIONE  
high pressure washers

## HEAVYPRO



giunto elastico  
flexible coupling

porta accessori  
built-in accessories holder

copertura in acciaio inox  
stainless steel cover

battistrada antitraccia  
non-marking wheels



### Caratteristiche Generali

- Struttura robusta con cofano in acciaio inox
- Pompa a 3 pistoni in ceramica con sistema biella- manovella
- Guarnizioni in teflon che permettono di utilizzare acqua ad una temperatura massima in ingresso di 85°
- Valvola di by-pass automatica con azzeramento della pressione nella testa della pompa
- Motore elettrico trifase
- Flangia con giunto elastico per accoppiamento pompa-motore
- Valvola di regolazione flangiata
- Tubo rinforzato antitraccia (10 m)
- Battistrada antitraccia

### • General Features

- Heavy-duty frame with stainless steel cover
- Triplex pump with ceramic pistons and connecting rod system
- Teflon gasket to allow cleaning at high temperature. Max inlet water temperature 85°
- Automatic by-pass valve with pump head pressure discharge
- Heavy-duty three-phase motor
- Flange with elastic joint for pump-motor coupling
- Flanged unloader valve
- Non-marking reinforced hose (10 m)
- Non-marking wheels

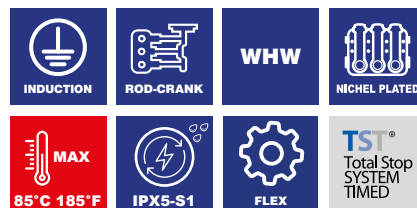

MOD	COD	MAX		MAX								KG NET		
		bar max	bar work	psi max	psi work	l/h work	gph work	hp	kW	kW work	rpm	Hz	V	kg
1018H	25272-V	230	200	3335	2900	900	237	7,5	5,5	7,4	1450	50	400 3~	80

### Accessori standard Standard accessories







## HEAVYPRO

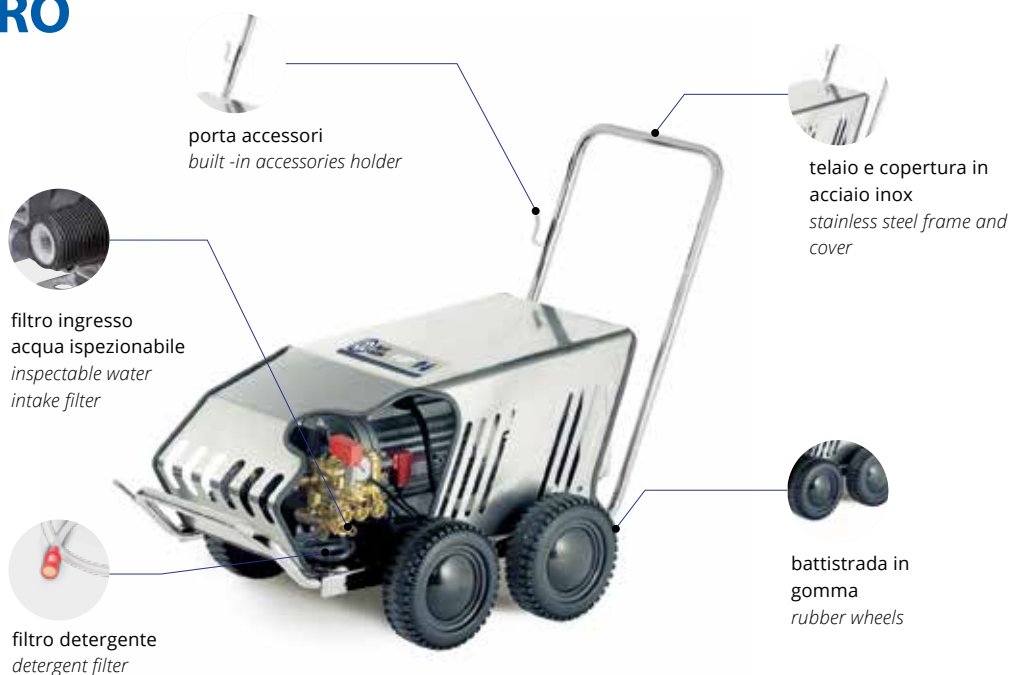

### Caratteristiche Generali

- Struttura robusta con cofano in acciaio inox
- Pompa a 3 pistoni in ceramica con sistema biella- manovella
- Testa pompa in ottone
- Valvola di by-pass automatica con azzeramento della pressione nella testa della pompa
- Arresto per microperdite
- Arresto dopo 1 ora di Total Stop
- Arresto per mancanza d'acqua
- Arresto per surriscaldamento motore
- Segnalazione d'errore tramite spia intermittente
- Motore elettrico trifase
- Regolazione pressione
- Aspirazione detergente incorporata
- Tubo rinforzato con treccia in acciaio (10 m)
- Funzione autoadescente
- Pistola con swivel

### General Features

- Heavy-duty frame with stainless steel cover
- Triplex pump with ceramic pistons and connecting rod system
- Brass pump head
- Automatic by-pass valve with pump head pressure discharge
- Stop for leak detention
- Stop after 1 hour of total stop
- Stop for lack of water
- Stop for motor overloading
- System error warning light
- Heavy-duty three-phase motor
- Pressure adjustment
- Built-in detergent suction
- Steel braided hose (10 m)
- Self-priming function
- Gun with swivel

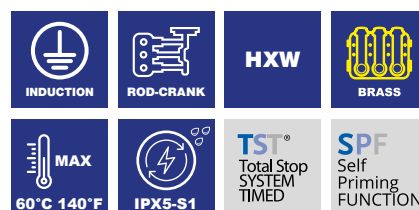

MOD	COD	MAX		MAX		MAX		MAX		MAX		MAX		KG NET
		bar max	bar work	psi max	psi work	l/h work	gph work	hp	kW	kW work	rpm	Hz	V	kg
1120	22374-V	230	200	3335	2900	1260	333	10	7,5	9,3	1450	50	400 3~	110

### Accessori standard Standard accessories





# 14 New Series

## THE POWER OF CLEANING

Idropultrici extra-flessibili - indipendenti dall'alimentazione elettrica. Alimentate a benzina, sono la soluzione ideale per la pulizia nel settore agricolo ed edile dove sono richieste prestazioni elevate ed un'estrema manovrabilità. Robuste e prestanti sono la risposta migliore per questo tipo di utilizzi gravosi e continuati. Le pompe montate su queste idropultrici sono costruite utilizzando esclusivamente materiali di qualità e anti-corrosione, quali l'ottone. Offrono quindi una lunga durata ed un'estrema facilità di manutenzione.

## THE POWER OF CLEANING

*Highly versatile high pressure washers - with no electricity supply needed. Operating on petrol, they are the ideal solution for cleaning in the farming and construction sectors, where high performance and extreme manoeuvrability are required. Tough and high-performing, they are the best solution for this type of heavy-duty, continuous use. The pumps installed on these high pressure washers are built only from top quality, corrosion-resistant materials, such as brass. This ensures a long working lifetime and exceptionally easy maintenance.*





filtra ingresso  
acqua ispezionabile  
inspectable water  
intake filter

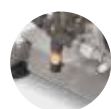

valvola termica  
thermal valve



porta accessori  
built-in accessories holder



manico ergonomico  
ergonomic handle



piedi antivibranti  
damper feet





### Caratteristiche Generali

- Telaio completo di manico con piedini antivibranti
- Pompa a 3 pistoni assiali comandati dal piattello oscillante
- Valvola di sicurezza automatica
- Valvola termica
- Aspirazione detergente incorporata
- Aspirazione detergente regolabile
- Motorizzato Lifan (benzina) con sensore mancanza olio
- Livelli olio ispezionabili
- Tappi ed asole di scarico per agevolare la manutenzione ed il cambio olio
- Filtro acqua ispezionabile
- Soluzioni studiate per ottimizzare gli ingombri
- Tubo alta pressione (5 m)

### General Features

- Metal frame with handle and anti-vibrating feet
- 3 Axial stainless steel pistons wobble-plate pump
- Automatic safety valve
- Thermal valve
- Built-in detergent suction
- Powered by Lifan petrol engine with low oil level sensor
- Inspectable oil levels
- Discharge plugs and discharge slots to make easy the maintenance and the oil change
- Inspectable water filter
- Space-saving solutions
- High pressure hose (5 m)



MOD	COD	 MAX	 MAX						
		bar max	psi max	l/h max	gph max	rpm	Engine	kW	kg
1415	26213	130	1885	420	111	3400	LIFAN 152F-1,5	1,1	17,3

### Accessori standard

Standard accessories



46328



46332



4381820



4000870  
(5 m)



# 14 Series 1425

IDROPULTRICI CON MOTORE A SCOPPIO  
petrol engine pressure washers



porta accessori  
built-in accessories holder

manico ergonomico  
ergonomic handle

filtro ingresso acqua ispezionabile  
inspectable water intake filter

valvola termica  
thermal valve

telaio in acciaio verniciato  
painted steel frame

battistrada in gomma  
rubber wheels





## Caratteristiche Generali

- Carrello completo di manico con due ruote e piedini antivibranti
- Pompa a 3 pistoni assiali comandati dal piattello oscillante
- Valvola di sicurezza automatica
- Regolazione della pressione
- Valvola termica
- Aspirazione detergente incorporata
- Motorizzato Rato (benzina)
- Livelli olio ispezionabili
- Tappi ed asole di scarico per agevolare la manutenzione ed il cambio olio
- Filtro acqua ispezionabile
- Soluzioni studiate per ottimizzare gli ingombri
- Tubo alta pressione (8 m)

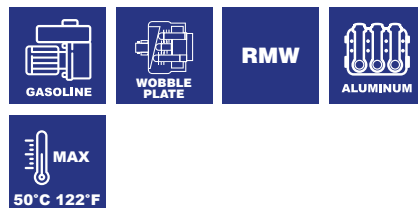
## General Features

- Two-wheel trolley with tyres, handle and anti-vibrating feet
- 3 Axial stainless steel pistons wobble-plate pump
- Automatic safety valve
- Thermal valve
- Built-in detergent suction
- Powered by Rato petrol engine
- Inspectable oil levels
- Discharge plugs and discharge slots to make easy the maintenance and the oil change
- Inspectable water filter
- Space-saving solutions
- High pressure hose (8 m)



MOD	COD	 MAX	 MAX						
		bar max	psi max	l/h max	gph max	rpm	Engine	kW	kg
1425	26215	160	2320	580	480	3400	RATO EHRV175 - 4	3	25,9

## Accessori standard Standard accessories



43471



3600650



3780492 (8 m)



3600400 (low pressure) Nero/Black  
 3600440 (0003) Rosso/Red  
 3600450 (1503) Giallo/Yellow  
 3600470 (4003) Bianco/White





### OLIGHTPRO



#### Caratteristiche Generali

- Carrello completo di manico con due ruote e piedini antivibranti
- Pompa a 3 pistoni assiali comandati dal piattello oscillante
- Valvola di sicurezza automatica
- Regolazione della pressione
- Valvola termica
- Aspirazione detergente incorporata
- Motorizzato Loncin (benzina) con sensore mancanza olio
- Livelli olio ispezionabili
- Tappi ed asole di scarico per agevolare la manutenzione ed il cambio olio
- Filtro acqua ispezionabile
- Soluzioni studiate per ottimizzare gli ingombri
- Tubo rinforzato con treccia in acciaio (8 m)

#### General Features

- Two-wheel trolley with tyres, handle and anti-vibrating feet
- 3 Axial stainless steel pistons wobble-plate pump
- Automatic safety valve
- Pressure adjustment
- Thermal valve
- Built-in detergent suction
- Powered by Loncin petrol engine with low oil level sensor
- Inspectable oil levels
- Discharge plugs and discharge slots to make easy the maintenance and the oil change
- Inspectable water filter
- Space-saving solutions
- Steel braided hose (8 m)

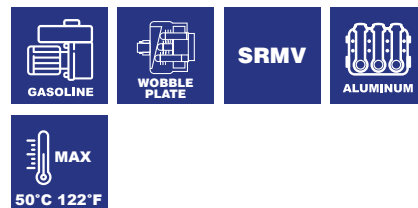

MOD	COD	MAX		MAX		Engine		KG NET	
		bar max	psi max	l/h max	gph max	rpm	kW	kg	
1435	26406	200	2900	660	174	3400	LONCIN G200F - 5,3	4,1	31,8

#### Accessori standard

Standard accessories







# 14 Series 1440

IDROPULTRICI CON MOTORE A SCOPPIO  
petrol engine pressure washers

## OLIGHTPRO



### Caratteristiche Generali

- Carrello completo di manico con due ruote e piedini antivibranti
- Pompa a 3 pistoni assiali comandati dal piattello oscillante
- Valvola di sicurezza automatica
- Valvola termica
- Aspirazione detergente incorporata
- Motorizzato Honda (benzina) con sensore mancanza olio
- Livelli olio ispezionabili
- Tappi ed asole di scarico per agevolare la manutenzione ed il cambio olio
- Filtro acqua ispezionabile
- Soluzioni studiate per ottimizzare gli ingombri
- Tubo rinforzato con treccia in acciaio (8 m)

### General Features

- Two-wheel trolley with tyres, handle and anti-vibrating feet
- 3 Axial stainless steel pistons wobble-plate pump
- Automatic safety valve
- Thermal valve
- Built-in detergent suction
- Powered by Honda petrol engine with low oil level sensor
- Inspectable oil levels
- Discharge plugs and discharge slots to make easy the maintenance and the oil change
- Inspectable water filter
- Space-saving solutions
- Steel braided hose (8 m)



MOD	COD	MAX	MAX		NET				
		bar max	psi max	l/h max	gph max	rpm	Engine	kW	kg
1440	26216	200	2900	660	174	3400	HONDA GP160 - 4,8	3,6	31,4

### Accessori standard Standard accessories





## OLIGHTPRO



porta accessori  
built-in accessories holder



filtro ingresso  
acqua ispezionabile  
inspectable water  
intake filter



valvola termica  
thermal valve



manico ergonomico  
ergonomic handle



telaio in acciaio  
verniciato  
painted steel frame



battistrada in gomma  
rubber wheels

**1445XE  
TRADE  
SELECTION**



### Caratteristiche Generali

- Carrello completo di manico con due ruote e piedini antivibranti
- Pompa a 3 pistoni assiali comandati dal piattello oscillante
- Valvola di sicurezza automatica
- Regolazione della pressione
- Valvola termica
- Aspirazione detergente incorporata
- Motorizzato Rato (benzina), con sensore mancanza olio
- Livelli olio ispezionabili
- Tappi ed asole di scarico per agevolare la manutenzione ed il cambio olio
- Filtro acqua ispezionabile
- Soluzioni studiate per ottimizzare gli ingombri
- Tubo rinforzato con treccia in acciaio (8 m)

### General Features

- Two-wheel trolley with tyres, handle and anti-vibrating feet
- 3 Axial stainless steel pistons wobble-plate pump
- Automatic safety valve
- Pressure adjustment
- Thermal valve
- Built-in detergent suction
- Powered by Rato petrol engine with low oil level sensor
- Inspectable oil levels
- Discharge plugs and discharge slots to make easy the maintenance and the oil change
- Inspectable water filter
- Space-saving solutions
- Steel braided hose (8 m)



MOD	COD	MAX	MAX		NET				
		bar max	psi max	l/h max	gph max	rpm	Engine	kW	kg
1445	26407	220	3200	660	174	3400	RATO EHR210 - 5,9	4,4	31,7
1445 XE	27856	220	3200	660	174	3400	RATO EHR210 - 5,9	4,4	31,7

### Accessori standard Standard accessories



43525



3600650



41050 (1445 XE)



43473 (8 m)



- 3600400 (low pressure) Nero/Black
- 3600930 (00035) Rosso/Red
- 3600940 (15035) Giallo/Yellow
- 3600960 (40035) Bianco/White



# 14 Series 1447

IDROPULTRICI CON MOTORE A SCOPPIO  
petrol engine pressure washers

## HEAVYPRO



porta accessori  
built-in accessories holder

manico ergonomico  
ergonomic handle

filtro ingresso  
acqua ispezionabile  
inspectable water  
intake filter

telaio in acciaio  
verniciato  
painted steel frame

valvola termica  
thermal valve

battistrada in gomma  
rubber wheels



### Caratteristiche Generali

- Carrello completo di manico con due ruote e piedini antivibranti
- Pompa a 3 pistoni assiali comandati dal piattello oscillante
- Valvola di sicurezza automatica
- Regolazione della pressione
- Valvola termica
- Aspirazione detergente incorporata
- Motorizzato Rato (benzina) con sensore mancanza olio
- Livelli olio ispezionabili
- Tappi ed asole di scarico per agevolare la manutenzione ed il cambio olio
- Soluzioni studiate per ottimizzare gli ingombri
- Tubo rinforzato con treccia in acciaio (10 m)

### General Features

- Two-wheel trolley with tyres, handle and anti-vibrating feet
- 3 Axial stainless steel pistons wobble-plate pump
- Automatic safety valve
- Pressure adjustment
- Thermal valve
- Built-in detergent suction
- Powered by Rato petrol engine with low oil level sensor
- Inspectable oil levels
- Discharge plugs and discharge slots to make easy the maintenance and the oil change
- Space-saving solutions
- Steel braided hose (10 m)

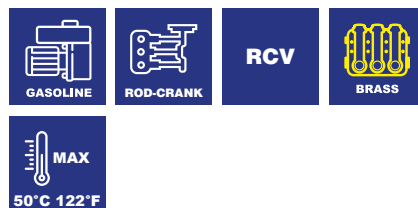

MOD	COD	MAX				MAX					Engine	kW	kg NET
		bar max	bar work	psi max	psi work	l/h max	l/h work	gph max	gph work	rpm			
1447	26578	220	180	3150	2610	720	600	190	159	3400	RATO EHR210 -	5,6	4,2 34,7

### Accessori standard Standard accessories



43525



3600650



3780443 (10 m)



3600400 (low pressure) Nero/Black  
 3600930 (00035) Rosso/Red  
 3600940 (15035) Giallo/Yellow  
 3600960 (40035) Bianco/White



### HEAVYPRO



### Caratteristiche Generali

- Carrello completo di manico con due ruote e piedini antivibranti
- Pompa a pistoni con sistema biella-manovella ad elevate prestazioni
- Valvola di sicurezza automatica
- Regolazione della pressione
- Valvola termica
- Aspirazione detergente incorporata
- Motorizzato Honda (benzina), con sensore mancanza olio
- Livelli olio ispezionabili
- Tappi ed asole di scarico per agevolare la manutenzione ed il cambio olio
- Filtro acqua ispezionabile
- Soluzioni studiate per ottimizzare gli ingombri
- Tubo rinforzato con treccia in acciaio (10 m)

### General Features

- Two-wheel trolley with tyres, handle and anti-vibrating feet
- High performance piston pump with connecting rod system
- Automatic safety valve
- Pressure adjustment
- Thermal valve
- Built-in detergent suction
- Powered by Honda petrol engine with low oil level sensor
- Inspectable oil levels
- Discharge plugs and discharge slots to make easy the maintenance and the oil change
- Space-saving solutions
- Steel braided hose (10 m)

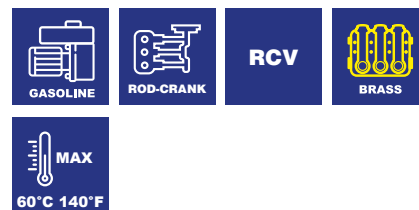

MOD	COD	 MAX				 MAX				 Engine	 kg		
		bar max	bar work	psi max	psi work	l/h max	l/h work	gph max	gph work	rpm	kW	kg	
1450	26217	220	160	3150	2320	720	600	190	159	3400	HONDA GP200 - 5,8	4,3	34,7

### Accessori standard

Standard accessories



43525



3600650



3780443 (10 m)



3600400 (low pressure) Nero/Black  
 3600930 (00035) Rosso/Red  
 3600940 (15035) Giallo/Yellow  
 3600960 (40035) Bianco/White

### HEAVYPRO

**1475XE  
TRADE  
SELECTION**



porta accessori  
built-in accessories holder

filtro ingresso  
acqua ispezionabile  
inspectable water  
intake filter

valvola termica  
thermal valve



Model 1475

manico ergonomico  
ergonomic handle

regolatore automatico acceleratore  
automatic throttle control  
Mod. 1475-1480

telaio in acciaio  
verniciato  
painted steel frame

battistrada in gomma  
rubber wheels

### Caratteristiche Generali

- Carrello completo di manico con due ruote pneumatiche gonfiabili e piedini antivibranti
- Pompa a pistoni con sistema biella-manovella ad elevate prestazioni
- Valvola di by-pass automatica
- Regolazione della pressione
- Valvola termica
- Aspirazione detergente incorporata
- Motorizzato Honda/Loncin (benzina) con sensore mancanza olio
- Livelli olio ispezionabili
- Tappi ed asole di scarico per agevolare la manutenzione ed il cambio olio
- Soluzioni studiate per ottimizzare gli ingombri
- Tubo rinforzato con treccia in acciaio (10 m)
- Funzione autoadescante

### General Features

- Two-wheel trolley with handle, inflatable pneumatic wheels and anti-vibrating feet
- High performance piston pump with connecting rod system
- Automatic by-pass valve
- Pressure adjustment
- Thermal valve
- Built-in detergent suction
- Powered by Honda/Loncin petrol engine with low oil level sensor
- Inspectable oil levels
- Discharge plugs and discharge slots to make easy the maintenance and the oil change
- Space-saving solutions
- Steel braided hose (10 m)
- Self-priming function

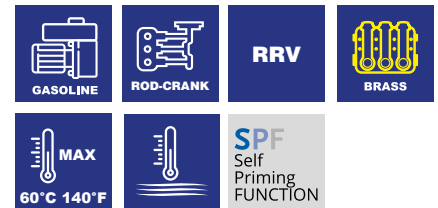

MOD	COD	MAX				MAX				rpm	Engine	kW	kg
		bar max	bar work	psi max	psi work	l/h max	l/h work	gph max	gph work				
1460	26218	270	230	4000	3335	900	830	238	190	3400	HONDA GX270 - 8,4	6,3	50,9
1475	26325	280	230	4060	3335	960	830	254	219	3400	LONCIN GF390 - 11	8,2	58,4
1475 XE	27857	280	230	4060	3335	960	830	254	219	3400	LONCIN GF390 - 11	8,2	58,4
1480	26219	280	230	4060	3335	960	840	254	222	3400	HONDA GX390 - 11,7	8,7	57,1

### Accessori standard Standard accessories



43524



3600650



1700981 (10 m)



1460 1475.1480  
3600400 (low p.) 3600400 (low p.) Nero/Black  
3600930 (00035) 3600350 (0004) Rosso/Red  
3600940 (15035) 3600360 (1504) Giallo/Yellow  
3600960 (40035) 3600380 (4004) Bianco/White



40964 (1475 XE)





### HEAVYPRO



### Caratteristiche Generali

- Carrello completo di manico con due ruote pneumatiche gonfiabili e piedini antivibranti
- Pompa a pistoni con sistema biella-manovella ad elevate prestazioni
- Pompa con testa nichelata
- Valvola di by-pass automatica
- Regolazione della pressione
- Valvola termica / Riduttore di giri
- Aspirazione detergente incorporata
- Motorizzato Honda (benzina), con sensore mancanza olio
- Livelli olio ispezionabili, per pompa e riduttore
- Tappi ed asole di scarico per agevolare la manutenzione ed il cambio olio
- Soluzioni studiate per ottimizzare gli ingombri
- Tubo rinforzato con treccia in acciaio (10 m)
- Funzione autoadescante

### General Features

- Two-wheel trolley with inflatable tyres, handle and damper feet inflatable pneumatic wheels and anti-vibrating feet
- High performance piston pump with connecting rod system
- Pump with nickel plated head
- Automatic by-pass valve
- Pressure adjustment
- Thermal valve / Gear box
- Built-in detergent suction
- Powered by Honda petrol engine with low oil level sensor
- Inspectable oil levels for pump and gear box
- Discharge plugs and discharge slots to make easy the maintenance and the oil change
- Space-saving solutions
- Steel braided hose (10 m)
- Self-priming function

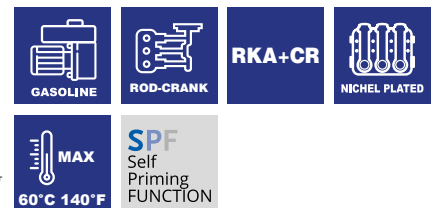

MOD	COD	MAX				MAX							
		bar max	bar work	psi max	psi work	l/h max	l/h work	gph max	gph work	rpm	Engine	kW	kg NET
1490	26408	280	230	4060	3335	960	830	254	219	1750	HONDA GX390 - 11,7	8,7	64

### Accessori standard Standard accessories



43524

3600650

1700981 (10 m)

3600400 (low pressure) Nero/Black  
3600350 (0004) Rosso/Red  
3600360 (1504) Giallo/Yellow  
3600380 (4004) Bianco/White

**ACCESSORI**

*Accessories*



















		5 Series		7 Series	6 Series										7 Series		9 Series			
		589	591	7.0	611	613	614	613K	614K	670	671	680	680K	630	630K	780	787	930	960	980
Pistola Trigger gun		46575	S	S																
		43471				S	S	S	S	S	S									
		46880			S							S	S			S	S	S	S	
		47039																		S
		47209												S	S			O	O	O
		47049			S															
Lancia getto regolabile Lance with adjustable spray nozzlex		46576	S																	
		46577		S																
		43472 (49 cm)				S		S												
		41806 (49 cm)					S		S											
		41747 (49 cm)														S				
		41271 (49 cm)															S			
		41929 (56 cm)																S		
		46818 (49 cm)			S															
		43954 (49 cm)								S										
		43955 (49 cm)									S									
		46816 (49 cm)										S	S							
Prolunga lancia Lance extension		47050 (41 cm)			S															
		46221 (56 cm)																	S	S
Ugello doppio PRO Double nozzle PRO		47051			S															
Testina getto regolabile Adjustable jet nozzle		47052			S															
Ugelli Wash nozzles 1/4 MEG		3086 (15045)																	S	S
		3157 (1508)																O		
Lancia getto rotante Rotary lance		46578	S	S																
		40638 (56 cm)				O						O	O	O	O	O				
		40167 (56 cm)					O		O											
		40169 (56 cm)									O									
Lancia getto rotante PRO Rotary lance PRO		40151 (56 cm)					O		O	O										
		40968 (56 cm)															O	O		
Tubo armato AP Reinforced HP hose		40803 (56 cm)																	O	O
		46581 (10 m)	S	S	S															

**Legenda: "S" Accessorio di serie - "O" Accessorio opzionale**  
 "S" On board accessory - "O" Optional accessory

# 6·9 Series

ACCESSORI  
accessories

































		5 Series		7 Series	6 Series										7 Series		9 Series			
		589	591	7.0	611	613	614	613K	614K	670	671	680	680K	630	630K	780	787	930	960	980
Tubo armato AP Reinforced HP hose		3960920 (8 m)			S								S	S						
		47024 (8 m)							S	S										
		43473 (8 m)				S	S													
		3780441 (10 m)						S	S											
		3960970 (10 m)												S	S			S		
		3961050 (10 m)														S	S		S	S
Prolunga tubo armato Reinforced extension hose		40106 incluso nel kit / included in kit 1123890	O	O	O	O	O	O	O	O	O	O	O	O	O	O	O	O	O	O
		46582 (10 m)	O	O	O	O	O	O	O	O	O	O	O	O	O					
Kit pulizia tubazioni Pipe drain kit		41588 (10 m)	O	O	O															
		41693 (16 m)	O	O	O															
Kit schiumogeno alta pressione High pressure foam lance bottle		46580	S	S	S															
		41552	O	O	O	O	O	O	O	O	O	O	O	O	O	O	O	O	O	O
Kit HYG HYG kit		46742			O	O	O	O	O	O										
Kit pulizia tubazioni Pipe drain kit		46364 (8 m)	O	O	O	O	O	O	O	O	O	O	O	O	O	O	O	O	O	
		46366 (16 m)	O	O	O	O	O	O	O	O	O	O	O	O	O	O	O	O	O	
Spazzola fissa Fixed brush		46353			O															
		41577	O	O	O	O	O	O	O	O	O	O	O	O						
Spazzola rotante Rotary brush		41578	O	O	O	O	O	O	O	O	O	O	O	O						
Spazzola lavante Power brush		46361	O	O	O	O	O	O	O	O	O	O	O	O						
Spazzola rotante PRO Rotary brush PRO		46370													O	O	O	O	O	
Lavapavimenti d. 30 cm Patio cleaner d. 30 cm		41687	O	O	O	O	O	O	O	O	O	O	O	O						
		46359	O	O	O	O	O	O	O	O	O	O	O	O						
Lavapavimenti PRO con regolazione pressione Patio cleaner w. pressure adjustment		46368	O	O	O	O	O	O	O	O	O	O	O	O						
		46369			O								O	O	O	O	O	O	O	
Kit lancia sabbia PRO Sandblasting lance kit PRO		41591 (50 cm)			O	O	O	O	O	O										
		41762 (50 cm)	O	O	O							O	O	O	O	O	O	O	O	





# 6-9 Series

ACCESSORI  
accessories

			5 Series		7 Series	6 Series										7 Series		9 Series			
			589	591	7.0	611	613	614	613K	614K	670	671	680	680K	630	630K	780	787	930	960	980
Sabbia calibrata e filtrata <i>Calibrated, filtered sand</i>		3207 (5 Kg)	O	O	O	O	O	O	O	O	O	O	O	O	O	O	O	O	O	O	O
		41770 (25 Kg)	O	O	O	O	O	O	O	O	O	O	O	O	O	O	O	O	O	O	O
Kit adescamento <i>Self priming kit</i>		41592	O	O	O	O	O	O	O	O	O	O	O	O	O	O	O	O	O	O	O
		47332	O	O	O	O	O	O	O	O	O	O	O	O	O	O					
		47333															O	O	O	O	O
Kit lancia sottococca <i>Underbody lance kit</i>		41590 (1503-80cm)	O	O		O	O	O	O	O	O	O	O								
		41751 (1504-80cm)															O		O		
		46372 (15045-80cm)			O											O	O		O		O
Lancia senza ugello <i>Lance without nozzle</i>		40652 (90 cm)				O	O	O	O	O	O	O	O	O	O	O	O	O	O	O	O
		40653 (120 cm)				O	O	O	O	O	O	O	O	O	O	O	O	O	O	O	O
		40654 (150 cm)				O	O	O	O	O	O	O	O	O	O	O	O	O	O	O	O
		40694 (170 cm)				O	O	O	O	O	O	O	O	O	O	O	O	O	O	O	O
		40695 (200 cm)				O	O	O	O	O	O	O	O	O	O	O	O	O	O	O	O
Lancia doppia <i>Double lance</i>		3160620 (66 cm)															O	O	O	O	O
Ugello bassa pressione <i>Low pressure nozzle</i>		3251 (2525)															O	O	O	O	O
Testina doppio ugello <i>Roller nozzle</i>		3025															O	O	O	O	O
Kit adattatori <i>Adapters kit</i>		41758	O	O	O	O	O	O	O	O	O	O	O	O	O	O					
Filtro acqua ispezionabile <i>Inspectable water filter</i>		41663 (3 pcs)	S	S	S	S	S	S	S	S	S	S	S	S	S	S	O	O	O	O	O
Kit filtro acqua <i>Water filter kit</i>		41593	O	O	O	O	O	O	O	O	O	O	O	O	O	O	O	O	O	O	O
Kit attacco rapido <i>Click fast kit</i>		41580	O	O	O	O	O	O	O	O	O	O	O	O	O	O	O	O	O	O	O
Kit attacco rapido ottone <i>Brass click fast kit</i>		40439	O	O	O	O	O	O	O	O	O	O	O	O	O	O	O	O	O	O	O
Kit RLW senza tubo <i>Hose reel kit without hose</i>		41738				O	O	O	O	O	O	O	O	O	O						
		40645															O	O			
Kit RLW con 15 m tubo AP <i>with HP hose 15 m</i>		46904																	O	O	O
		41879				O*	O	O	O	O	O	O	O*	O	O*	O					
Kit carrello <i>Trolley kit</i>		41869				O	O	O					O								
		43972								O	O				O	O					
Kit avvolgitubo a muro senza tubo <i>Wall mounted hose reel without hose kit</i>		41739				O	O	O	O				O	O							
		47704													O	O					
Kit avvolgitubo a muro con tubo 15 m <i>Wall mounted hose reel with hose 15 m</i>		41880				O	O	O	O				O	O							
		47705								O	O										













**Legenda: "S" Accessorio di serie - "O" Accessorio opzionale**  
"S" On board accessory - "O" Optional accessory

\*in abbinamento kit carrello 41869 | 43972  
\*in combination trolley kit 41869 | 43972

# 10·11·14 Series

ACCESSORI  
accessories



		10 Series									11 Series	14 Series																
		1003	1003RLW	1003XE	1005	1006XE	1007	1007RLW	1007XE	1009	1009RLW	1015	1018	1018H	1120	1415	1425	1435	1440	1445	1445XE	1447	1450	1460	1475	1475XE	1480	1490
Pistola Trigger gun		43471															S	S	S									
		47209	O	O	O	S	O	S	S	O	S	S																
		47039	S	S	S	O	S	O	O	S																		
		41089												S														
		47684										S	S		S													
		46328														S												
		43524																							S	S	S	S
Lancia con testina alta/ bassa senza ugello <i>Lance with high/low pressure head w/out nozzle</i>		46221 (56 cm)	O	O	O	S	O	S	S	O	S	S	S		S		O	O	O	O	O	O	O	O	O	O	O	O
		50690												S														
Prolunga lancia <i>Lance Extension</i>		3600650	S	S	S		S		S							S	S	S	S	S	S	S	S	S	S	S	S	
		46332													S													
Testina getto regolabile <i>Adjustable jet nozzle</i>		4381820													S													
Ugelli Wash nozzles 1/4 MEG ***		3104 (1503)														O			O	O								
		3195 (15035)															O	O				O	O	O				
		3082 (1504)	O	O	O																				O	O	O	O
		3086 (15045)					O	S	S	O		S	S															
		3083 (1505)				S							S															
		3089 (2506)													S													
	3090 (2507)									S	S																	













(\*\*\*) Per modelli/For models: 1003, 1005, 1006, 1007, 1009, 1440, 1435, 1445, 1447, 1450, 1460, 1475, 1480, 1490, 1003XE, 1006XE, 1007XE: occorre comprare la lancia cod. 46221 per montare gli ugelli tipo MEG/ Buy even lance code 46221 to use MEG type nozzles

		10 Series										11 Series	14 Series																
		1003	1003RLW	1003XE	1005	1006XE	1007	1007RLW	1007XE	1009	1009RLW	1015	1018	1018H	1120	1415	1425	1435	1440	1445	1445XE	1447	1450	1460	1475	1475XE	1480	1490	
Ugelli** Nozzles		3600400 (bassa p./ low p.)	S	S	S		S	O	O	S							S	S	S	S	S		S	S	S	S	S	S	
		3600440(0003)															S			S	S								
		3600930(00035)																S	S				S	S					
		3600350(0004)	S	S	S																		S			S	S	S	S
		3600480(00045)					S	O	O	S																			
		3600450(1503)															S			S	S								
		3600940(15035)																S	S					S	S				
		3600360(1504)	S	S	S																		S			S	S	S	S
		3600490(15045)					S	O	O	S																			
		3600460(2503)																											
		3600370(2504)	S	S	S																								
		3600500(25045)					S	O	O	S																			
		3600470(4003)															S			S	S								
		3600960(40035)																S	S					S	S				
		3600380(4004)	S	S	S																		S			S	S	S	S
	3600510(40045)					S	O	O	S																				
Lancia getto rotante PRO Rotary lance PRO		41050 (56 cm)															O			O	S								
		40968 (56 cm)				O													O	O			O	O					
		40964 (56 cm)																							O	S	O	O	
		40803 (56 cm)						O	O	S			O	O	O								O	O					
		40966 (56 cm)																											
		40965 (56 cm)														O													
		40969 (56 cm)								O	O	O																	
		46635 (56 cm)	O	O	S																								
	46639 (56 cm)					S																							
Testina getto rotante Rotary jet nozzle		41565														O													

(\*\*\*) Per modelli/For models: 1007, 1007 RLW occorre comprare la lancia cod. 3600650 per montare gli ugelli/ Buy even lance code 3600650 to use nozzles

**Legenda: "S" Accessorio di serie - "O" Accessorio opzionale**  
"S" On board accessory - "O" Optional accessory











		10 Series										11 Series	14 Series																
		1003	1003RLW	1003XE	1005	1006XE	1007	1007RLW	1007XE	1009	1009RLW	1015	1018	1018H	1120	1415	1425	1435	1440	1445	1445XE	1447	1450	1460	1475	1475XE	1480	1490	
Tubo AP Hose HP		4000870 (5 m)														S													
		3780492 (8 m)															S												
		43473 (8 m) Reinforced																S	S	S	S								
		3780443 (10 m) Reinforced																				S	S						
		1271960 (10 m) Reinforced	S	S																									
		3961050 (10 m) Reinforced			S	S	S		S	S																			
		3600970 (15 m) Reinforced	S					S		S																			
		1700981 (10 m) Reinforced																						S	S	S	S	S	
		3160590 (10 m) Reinforced									S	S		S															
			3260590 (10 m) Reinforced Non marking										S																
Tubo aspirazione 100°C Suction hose 100°C		3260600 (70 cm)										S																	
Prolunga tubo Extension hose		41585 (8 m)													O														
Prolunga tubo armato Reinforced extension hose		46493 (10 m)																					O	O	O	O	O		
		40641 (15 m)	O	O	O	O	O										O	O	O										
		46849 (20m)																											
		40106 (15 m)					O	O	O	O	O	O	O	O		O					O	O	O	O					
		46850 (15m)																					O	O	O	O	O		
Kit schiumogeno alta pressione High pressure foam lance bottle		41552	O	O	O	O	O	O	O	O	O	O	O	O	O	O	O	O	O	O	O	O	O	O	O	O	O	O	
Kit pulizia tubazioni Pipe drain kit		46364 (8 m)	O	O	O	O	O	O	O		O					O	O	O	O	O	O	O	O	O	O	O	O	O	
		46365 (8 m)							O	O					O														
		46366 (16 m)	O	O	O	O	O	O	O		O	O				O	O	O	O	O	O	O	O	O	O	O	O	O	
		46367 (16 m)							O	O					O														
		1272520 (8 m)											O																
	1272530 (16 m)											O																	
Spazzola fissa Fixed brush		41577	O	O	O											O	O	O	O	O	O	O	O						







			10 Series										11 Series	14 Series														
			1003	1003RLW	1003XE	1005	1006XE	1007	1007RLW	1007XE	1009	1009RLW	1015	1018	1018H	1120	1415	1425	1435	1440	1445	1445XE	1447	1450	1460	1475	1475XE	1480
Lancia doppia senza ugelli <i>Double lance without nozzles</i>		3160620 (66 cm)	O	O	O	O	O	O	O	O	O	O	O	O	O	O	O	O	O	O	O	O	O	O	O	O	O	O
Ugello bassa pressione <i>Low pressure nozzle</i>		3251 (2525)	O	O	O	O	O	O	O	O	O	O	O	O	O	O	O	O	O	O	O	O	O	O	O	O	O	
Testina doppio ugello <i>Roller nozzle</i>		3025	O	O	O		O	O	O	O	O	O	O	O	O	O	O	O	O	O	O	O	O	O	O	O	O	
Kit adattatori <i>Adaptors kit</i>		41758	O	O	O												O	O	O	O	O	O						
Filtro acqua ispezionabile <i>Inspectable water filter</i>		41663 (3 pcs)	O	O	S	O	S	O	O	S	O	O	O		O	S	S	S	S	S	S	S	S	S	S	S	S	
Kit filtro acqua <i>Water filter kit</i>		41593	O	O	O	O	O	O	O	O	O	O		O	O	O	O	O	O	O	O	O	O	O	O	O	O	
Kit attacco rapido <i>Click fast kit</i>		41580	O	O	O	O	O	O	O	O	O	O		O	O	O	O	O	O	O	O	O	O	O	O	O	O	
Kit attacco rapido in ottone <i>Brass click fast kit</i>		40439	O	O	O	O	O	O	O	O	O	O		O	O	O	O	O	O	O	O	O	O	O	O	O	O	
Kit RLW senza tubo <i>Hose reel kit w/out hose</i>		42509	O	O	O	O	O	O	O																			
		42659								O	S																	
		51290										O																
		50272											O	O														
	50273													O														

# PRO HOT

Per utilizzi specifici dove l'acqua calda è un must, le idropultrici Annovi Reverberi con caldaia, soddisfano in pieno le esigenze più estreme di sanificazione e rimozione dello sporco, grazie a prestazioni top di categoria, alla loro tecnologia Made in Italy ed alla loro praticità d'utilizzo.

*For specific uses where hot water is a must, Annovi Reverberi high pressure washers with boiler meet the most extreme sanitisation and dirt removal requirements in full, thanks to class-topping performances, Italian technology and very convenient use.*



# Applicazioni ed indicatori di prestazioni PRO HOT

## *PRO HOT performance Indicators & Applications*

### BLUE CLEAN PRO LEVEL

#### ○ LIGHTPRO

Fascia di idropulitrici progettate per utilizzatori esperti che hanno necessità di eseguire lavori di pulizia abbastanza frequenti e che richiedono una abbondante riserva di potenza.

*High pressure washer category designed for skilled users tackling cleaning quite frequent jobs operations which need plenty of power in reserve.*

#### ● HEAVYPRO

Fascia di idropulitrici progettate per professionisti che hanno necessità di eseguire lavori di pulizia molto frequenti che richiedono le massime prestazioni.

*High pressure cleaner category designed for professionals, dealing with cleaning high frequent jobs that need the very highest-performing appliances.*

### BLUE CLEAN FACTOR



La combinazione ideale tra prestazioni tecniche e configurazione commerciale per poter risolvere al meglio le tue esigenze di pulizia. I prodotti che hanno il BLUE FACTOR sono i migliori, all'interno della loro categoria, per poter pulente, facilità d'utilizzo e prestazioni tecniche. Il mix perfetto per ogni tua esigenza di pulizia.

*The ideal combination of technical features and commercial configuration, to deliver the best solution to your cleaning needs. Products with the BLUE FACTOR are best-in-class in cleaning power, ease of use and technical performances. The perfect mix for all your cleaning requirements.*

## PROFESSIONAL APPLICATIONS

	<b>edilizia</b> construction
	<b>agricoltura zootecnica</b> agriculture zootechny
	<b>artigianato</b> crafts
	<b>car wash</b>
	<b>automotive</b>

Gamma di idropultrici pensate per le sollecitazioni di impiego più prestazionali. Ideali per il settore edile, agricolo e le municipalizzate – coniugano perfettamente il sapere costruttivo Annovi Reverberi con la praticità di un design semplice ma estremamente funzionale.

*Range of high pressure washers designed to withstand the most high-performing applications. Ideal for the construction industry, farming and utility companies, they are the ideal blend of Annovi Reverberi's construction know-how and the convenience of simple, stylish, highly functional design.*

						
<b>25 Series</b>						
2591		●	●			
<b>35 Series</b>						
3590		●	●			
<b>45 Series</b>						
4590		●	●	●		
<b>56 Series</b>						
5670		●	●	●		
<b>58 Series</b>						
5850		●	●	●		
5870		●	●	●		
<b>66 Series</b>						
6640		●	●	●		
6670		●	●	●		
<b>69 Series</b>						
6950		●	●	●	●	●
6970		●	●	●	●	●
<b>78 Series</b>						
7850		●	●	●	●	●
7870		●	●	●	●	●
<b>88 Series</b>						
8840		●	●	●	●	●
8860		●	●	●	●	●
8880		●	●	●	●	●
<b>13 Series</b>						
1310		●	●	●	●	●
1320		●	●	●	●	●
1325		●	●	●	●	●
1380		●	●	●	●	●



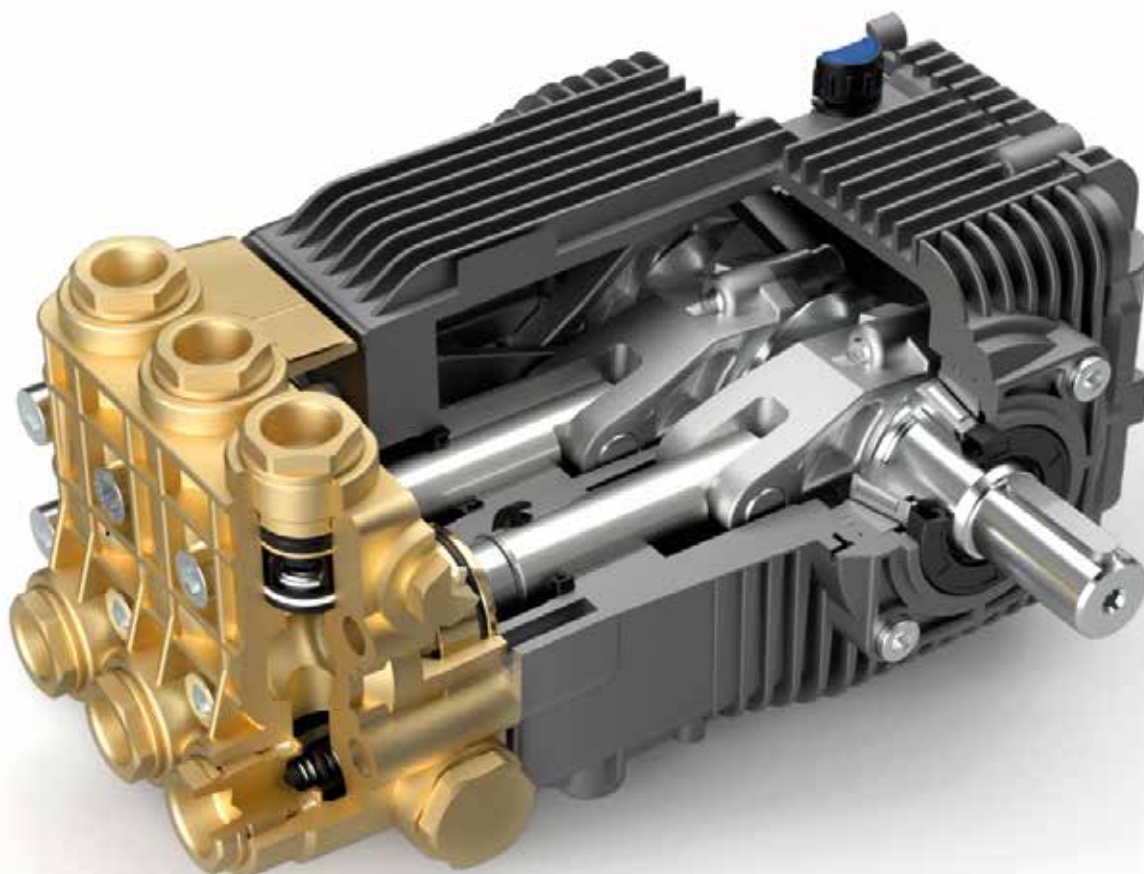

Pompa con sistema biella-manovella per utilizzo in orizzontale. Corpo e coperchi laterali con livello olio.  
Bielle in lega zinco-alluminio pressofuso.  
Testa in ottone forgiato con disegno ad alta resistenza.  
Pistoni in ceramica.  
Sistema di tenuta a doppia guarnizione.  
I componenti interni sono tutti di dimensioni maggiorate in grado di garantire una buona affidabilità e resistenza nel tempo.

*Wobble plate pump for orizontal use.  
Crankcase and side covers with oil level.  
Connecting rods in die-cast zinc-aluminium alloy.  
High strength forged brass head with design.  
Ceramic plungers.  
Double seal sealing system.  
The internal components are all oversized to ensure good reliability and durability.*

## HRM

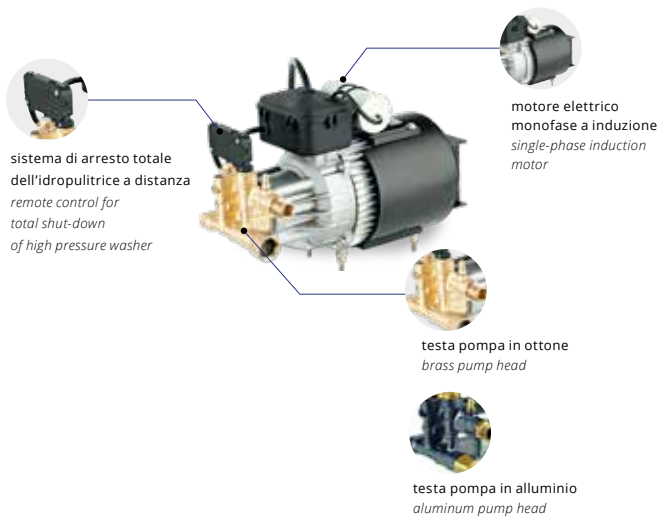

- Pompa a 3 pistoni assiali comandati dal piattello oscillante, testa ottone
- Pistoni in acciaio inox temperato
- Valvola di sicurezza automatica con azzeramento della pressione nella testa pompa
- Motore elettrico monofase a induzione con protezione termica
- Sistema di arresto totale dell'idropulitrice a distanza
- Pompa con testa in alluminio per mod. 2591, pompa con testa in ottone per mod. 3590

- 3 Axial stainless steel pistons wobble-plate pump with brass head
- Tempered stainless steel pistons
- Automatic by-pass valve with pump head pressure discharge
- Single-phase induction motor with thermal protector
- Remote control for total shut-down of high pressure washer
- Aluminium pump head for model 2591. Brass pump head for model 3590

- INDUCTION
- WOBBLE PLATE
- ALUMINIUM
- BRASS
- TSS® Total Stop SYSTEM

## HPV-O

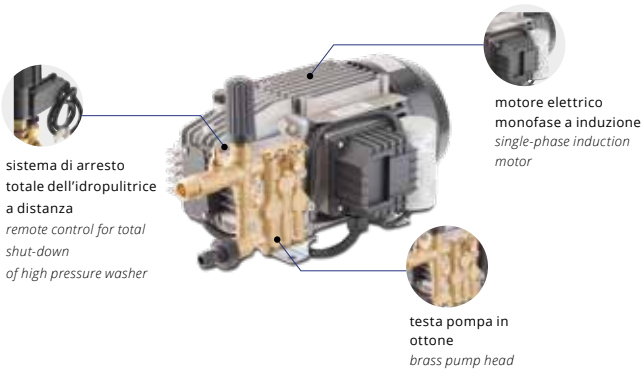

- Pompa a 3 pistoni in acciaio inox temperato con riporto ceramico con sistema biella-manovella, testa pompa in alluminio
- Valvola di sicurezza automatica con azzeramento della pressione nella testa pompa
- Motore elettrico monofase a induzione con protezione termica
- Sistema di arresto totale dell'idropultrice a distanza (mod. 4590)
- Sistema Total Stop temporizzato (mod. 5670)

- Triplex pump with tempered stainless steel ceramic coated pistons and connecting rod system with aluminum pump head
- Automatic by-pass valve with pump head pressure discharge
- Single-phase induction motor with thermal protection
- Remote control for total shut-down of high pressure washer (mod. 4590)
- Timed Total Stop system (mod. 5670)

- INDUCTION
- ROD-CRANK
- BRASS
- TSS® Total Stop SYSTEM
- TSS® Total Stop SYSTEM TIMED

## HRC



- Pompa a 3 pistoni in ceramica con sistema biella-manovella, testa pompa in ottone
- Valvola di bypass automatica con azzeramento della pressione nella testa pompa
- Motore elettrico monofase a induzione con protezione termica (3kW)
- Motore elettrico trifase a induzione con protezione termica (5kW)
- Sistema di arresto totale dell'idropultrice a distanza
- Sistema Total Stop temporizzato

- Triplex pump with ceramic pistons and connecting rod system with brass pump head
- Automatic by-pass valve with pump head pressure discharge
- Single-phase induction motor with thermal protection (3kW)
- Three-phase induction motor with thermal protection (5kW)
- Remote control for total shut-down of high pressure washer
- Timed Total Stop system

- INDUCTION
- ROD-CRANK
- BRASS
- TSS® Total Stop SYSTEM TIMED

## HRCS

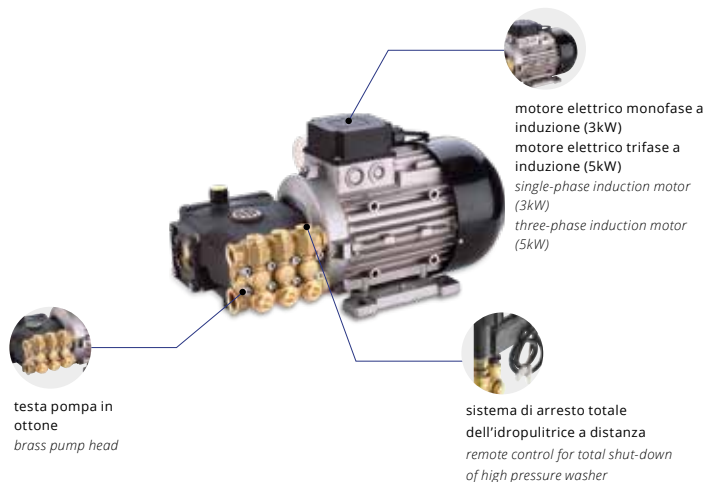

- Pompa a 3 pistoni in ceramica con sistema biella-manovella, testa pompa in ottone
- Valvola di bypass automatica con azzeramento della pressione nella testa pompa
- Motore elettrico monofase a induzione con protezione termica (3kW)
- Motore elettrico trifase a induzione con protezione termica (5kW)
- Sistema Total Stop temporizzato

- Triplex pump with ceramic pistons and connecting rod system with brass pump head
- Automatic by-pass valve with pump head pressure discharge
- Single-phase induction motor with thermal protection (3kW)
- Three-phase induction motor with thermal protection (5kW)
- Remote control for total shut-down of high pressure washer
- Inlet water suction from tank by self priming function



## HRR

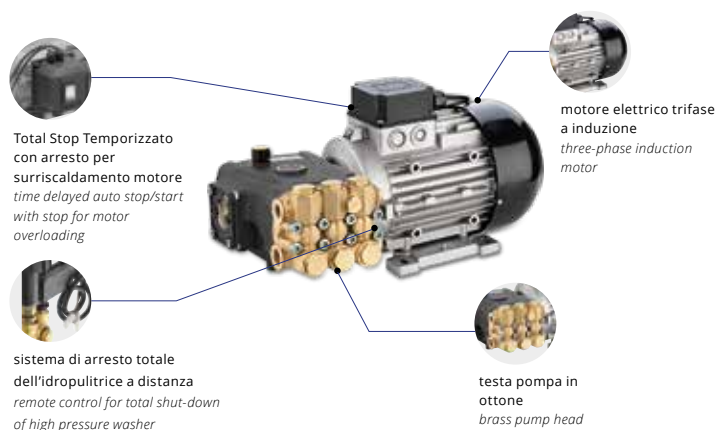

- Pompa a 3 pistoni in ceramica con sistema biella-manovella, testa pompa in ottone
- Valvola di bypass automatica con azzeramento della pressione nella testa pompa
- Motore elettrico trifase a induzione con protezione termica
- Sistema Total Stop temporizzato

- Triplex pump with ceramic pistons and connecting rod system with brass pump head
- Automatic by-pass valve with pump head pressure discharge
- Three-phase induction motor with thermal protection
- Remote control for total shut-down of high pressure washer
- Timed Total Stop system



## HRG

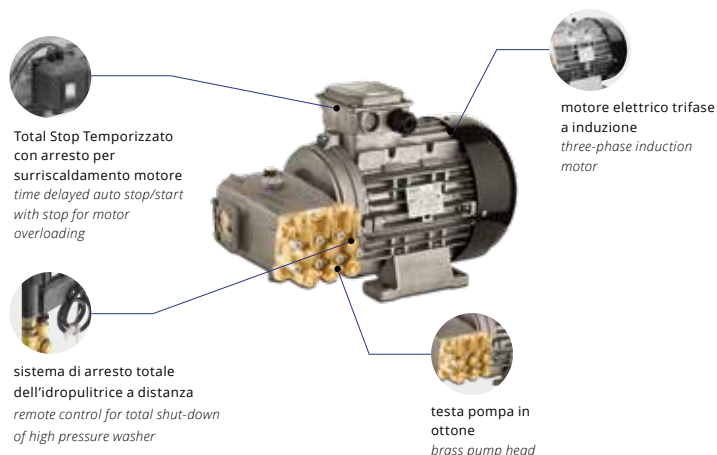

- Pompa a 3 pistoni in ceramica con sistema biella-manovella, testa pompa in ottone
- Valvola di sicurezza automatica con azzeramento della pressione nella testa pompa
- Motore elettrico trifase a induzione con protezione termica
- Sistema Total Stop temporizzato

- Triplex pump with ceramic pistons and connecting rod system with brass pump head
- Automatic by-pass valve with pump head pressure discharge
- Three-phase induction motor with thermal protection
- Time delayed auto stop/start with stop for motor overloading
- Timed Total Stop system





	HRM-A	HRM-O	HPV-O	HRC	HRCS	HRR	HRG
<b>2591</b>	●						
<b>3590</b>		●					
<b>4590</b>			●				
<b>5670</b>			●				
<b>5850</b>				●			
<b>5870</b>					●		
<b>6640</b>				●			
<b>6670</b>				●			
<b>6950</b>				●			
<b>6970</b>						●	
<b>7850</b>				●			
<b>7870</b>						●	
<b>8840</b>							●
<b>8860</b>							●
<b>8880</b>							●
<b>1310</b>			●				
<b>1320</b>				●			
<b>1325</b>				●			
<b>1380</b>						●	

SERIE - SERIES



# 25·35·45 Series

IDROPULTRICI ALTA PRESSIONE  
high pressure washers

## OLIGHTPRO

4590



porta accessori  
built-in accessories  
holder

battistrada in  
gomma  
rubber wheels

manico ergonomico  
ergonomic handle

caldaia in acciaio  
Stainless steel boiler

filtro ingresso acqua  
ispezionabile  
inspectable water  
intake filter

### Caratteristiche Generali

- Pompa a 3 pistoni assiali comandati da piattello oscillante (2591, 3590) o con sistema biella-manovella (4590)
- Pistoni in acciaio inox temprato
- Valvola di by-pass automatica con azzeramento della pressione nella testa della pompa
- Motore elettrico a induzione con protezione termica
- Pressostato di sicurezza per spegnimento della caldaia in caso di mancanza acqua
- Caldaia verticale, doppia serpentina e fondo in materiale refrattario
- Serbatoio gasolio 4 l
- Filtro acqua e filtro aspirazione gasolio
- Tubo rinforzato con treccia in acciaio (8 m)

### General Features

- 3 Axial stainless steel pistons wobble-plate pump (2591, 3590) or with connecting rod system (4590)
- Tempered stainless steel pistons
- Automatic by-pass valve with pump head
- pressure discharge
- Single-phase induction electric motor with thermal protector
- With safety pressure switch to shut down the boiler in case of lack of water
- Vertical boiler with double heating coil and refractory compound base
- Fuel tank capacity 4 l
- Water filter and fuel inlet filter
- Steel braided reinforced hose (8 m)

2591.3590 4590

HRM

HPV-O

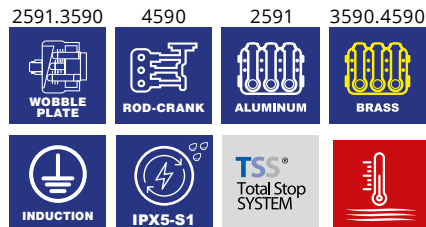

MOD	COD	MAX		MAX		MAX				KG NET	°C Max
		bar	psi	l/h	gph	kW	rpm	Hz	V		
2591	15376-V	140	2030	420	111	2,2	2800	50	230~	48	90
3590	24425-V	150	2175	450	119	2,4	2800	50	230~	52	90
4590	24426-V	160	2320	500	132	2,5	2800	50	230~	52,8	90

### Accessori standard Standard accessories



41047



50690



3164470  
(8 m)



3729 (2591.3590/15025)  
3104 (4590/1503)



40320







# 56 Series 5670

IDROPULTRICI ALTA PRESSIONE  
high pressure washers

## OLIGHTPRO



### Caratteristiche Generali

- Pompa a 3 pistoni assiali comandati dal piattello oscillante (5640) o con sistema biella-manovella (5670)
- Valvola di by-pass automatica con azzeramento della pressione nella testa della pompa
- Motore elettrico monofase con protezione termica
- Pressostato di sicurezza per spegnimento della caldaia in caso di mancanza acqua
- Caldaia verticale in acciaio inox, con sistema di raffreddamento bruciatore a chiocciola azionata da motore elettrico indipendente, doppia serpentina e fondo in cemento refrattario
- Scheda di ritardo per spegnimento caldaia
- Regolazione pressione
- Serbatoio gasolio 8 l, con tappo di scarico
- Termostato
- Aspirazione detergente incorporata
- Filtro acqua e filtro aspirazione gasolio
- Tubo rinforzato con treccia in acciaio (8 m)

### General Features

- 3 Axial stainless steel pistons wobble-plate pump (5640) or with connecting rod system (5670)
- Automatic by-pass valve with pump head pressure discharge
- Heavy-duty mono-phase motor with thermal protector
- With safety pressure switch to shut down the boiler in case of lack of water
- Stainless steel vertical boiler with coil burner cooling function driven by independent motor, double coil and refractory cement bottom
- Heating boiler shut-down delay circuit
- Pressure adjustment built-in
- Fuel tank with drain plug (8 l)
- Thermostat
- Built-in detergent suction
- Water filter and fuel inlet filter
- Steel braided reinforced hose (8 m)

HPV-O

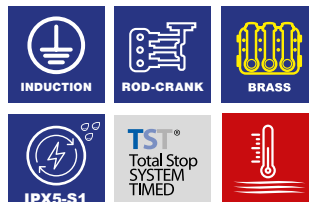

MOD	COD	MAX		MAX		MAX				KG NET	°C Max
		bar max	psi max	l/h max	gph max	kW	rpm	Hz	V	kg	
5670	25671-V	160	2320	500	132	2,5	2800	50	230~	80	100

### Accessori standard Standard accessories

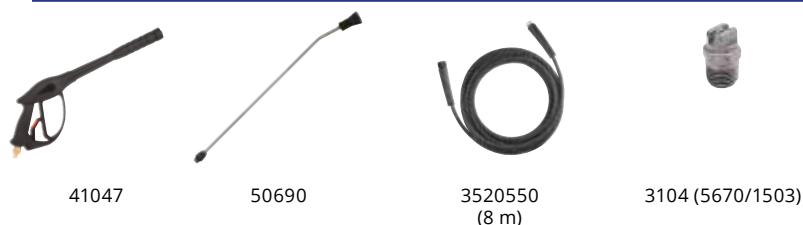



### HEAVYPRO



Spie: tensione, gasolio, fiamma.  
Termostato per regolazione  
temperatura acqua  
*Warning lights: power on, fuel,  
flame. Water temperature control  
thermostat*



battistrada in  
gomma  
*rubber wheels*



manico ergonomico  
*ergonomic handle*



caldaia in acciaio  
*Stainless steel boiler*



filtro ingresso acqua  
ispezionabile  
*inspectable water  
intake filter*



### Caratteristiche Generali

- Pompa a pistoni con sistema biella-manovella ad elevate prestazioni
- Valvola di by-pass automatica con azzeramento della pressione nella testa della pompa
- Pressostato di sicurezza per spegnimento della caldaia in caso di mancanza acqua
- Caldaia verticale in acciaio inox, con sistema di raffreddamento bruciatore a chiocciola azionata da motore elettrico indipendente, doppia serpentina e fondo in cemento refrattario
- Scheda di ritardo per spegnimento caldaia
- Regolazione pressione
- Serbatoio gasolio 8 l, con tappo di scarico
- Termostato
- Aspirazione detergente incorporata
- Filtro acqua e filtro aspirazione gasolio
- Tubo rinforzato con treccia in acciaio (8-10 m)

### General Features

- High performance piston pump with connecting rod system
- Automatic by-pass valve with pump head pressure discharge
- With safety pressure switch to shut down the boiler in case of lack of water
- Stainless steel vertical boiler with coil burner cooling function driven by independent motor, double coil and refractory cement bottom
- Heating boiler shut-down delay circuit
- Pressure adjustment built-in
- Fuel tank with drain plug (8 l)
- Thermostat
- Built-in detergent suction
- Water filter and fuel inlet filter
- Steel braided reinforced hose

5850

5870

**HRC**

**HRCS**



INDUCTION



ROD-CRANK



BRASS



IPX5-S1



TST®  
Total Stop  
SYSTEM  
TIMED



MOD	COD	MAX		MAX		MAX		MAX		MAX		MAX		MAX	
		bar max	bar work	psi max	psi work	l/h work	gph work	hp	kW	kW work	rpm	Hz	V	kg NET	°C Max
5850	25672-V	150	120	2175	1740	600	159	3	2,2	3	1450	50	230~	83	100
5870	25673-V	180	140	2600	2030	900	238	5	3,7	5	2800	50	400 3~	84	110

### Accessori standard Standard accessories



41047  
(5850)

41847  
(5870)

46221



3164470 (5850/8 m)  
3160160 (5870/10 m)



3082 (5850/1504)  
3095 (5870/15055)





# 66 Series 6640.6670

IDROPULTRICI ALTA PRESSIONE  
high pressure washers

## HEAVYPRO



### Caratteristiche Generali

- Pompa a 3 pistoni in ceramica con sistema biella-manovella
- Valvola di by-pass automatica con azzeramento della pressione nella testa della pompa
- Motore elettrico con protezione termica
- Pressostato di sicurezza per spegnimento della caldaia in caso di mancanza acqua
- Caldaia verticale in acciaio verniciato, con sistema di raffreddamento bruciatore a chiocciola azionata da motore elettrico indipendente, doppia serpentina e fondo in cemento refrattario
- Scheda di ritardo per spegnimento caldaia
- Regolazione pressione
- Serbatoio gasolio 22 l, con tappo di scarico
- Termostato
- Aspirazione detergente incorporata
- Serbatoio detergente 3,5/4 l incorporato
- Filtro acqua e filtro aspirazione gasolio
- Tubo rinforzato con treccia in acciaio

### General Features

- Triplex pump with ceramic pistons and connecting rod system
- Automatic by-pass valve with pump head pressure discharge
- Heavy-duty motor with thermal protector
- With safety pressure switch to shut down the boiler in case of lack of water
- Coated steel vertical boiler with coil burner cooling function driven by independent electric motor, double coil and refractory cement bottom
- Heating boiler shut-down delay circuit
- Pressure adjustment built-in
- Fuel tank with drain plug (22 l)
- Thermostat
- Built-in detergent suction
- Built-in detergent tank capacity 3.5/4 l
- Water filter and fuel inlet filter
- Steel braided reinforced hose

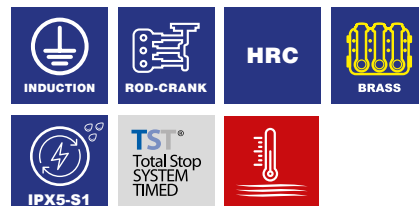

MOD	COD	MAX		MAX		MAX		MAX		MAX		MAX		KG NET	°C Max
		bar max	bar work	psi max	psi work	l/h work	gph work	hp	kW	kW work	rpm	Hz	V	kg	°C
6640	25275-V	150	130	2175	1885	600	159	3	2,2	3	1450	50	230~	82	110
6670	25288-V	190	170	2750	2465	780	206	5,5	4	5	1450	50	400 3~	85	110

### Accessori standard Standard accessories



41089



46221



3160160  
(10 m)



3082 (6640/1504)  
3086 (6670/15045)

# 69 Series 6950.6970

IDROPULTRICI ALTA PRESSIONE  
high pressure washers



## HEAVYPRO



manico ergonomico  
ergonomic handle



battistrada in gomma  
rubber wheels



Dispositivo di avviamento per il funzionamento a freddo e caldo  
Termostato per regolazione temperatura acqua  
Starter device for cold and hot water operation  
Flame water temperature control thermostat



caldaia in acciaio  
Stainless steel boiler



filtro ingresso acqua ispezionabile  
inspectable water intake filter

### Caratteristiche Generali

- Pompa a 3 pistoni in ceramica con sistema biella-manovella
- Valvola di by-pass automatica con azzeramento della pressione nella testa della pompa
- Motore elettrico trifase con protezione termica
- Sistema di arresto totale dell'idropulitrice a distanza
- Pressostato di sicurezza per spegnimento della caldaia in caso di mancanza acqua
- Caldaia verticale in acciaio inox, con sistema di raffreddamento bruciatore a chiodi azionata da motore elettrico indipendente, doppia serpentina e fondo in cemento refrattario
- Scheda di ritardo per spegnimento caldaia
- Regolazione pressione
- Serbatoio gasolio 14 l, con tappo di scarico
- Termostato
- Aspirazione detergente incorporata
- Serbatoio detergente 6 l incorporato
- Filtro acqua e filtro aspirazione gasolio
- Lunghezza cavo elettrico 5 m
- Tubo rinforzato con treccia in acciaio (10 m)

### General Features

- Triplex pump with ceramic pistons and connecting rod system
- Automatic by-pass valve with pump head pressure discharge
- Heavy-duty three-phase motor with thermal protector
- Remote control for total shut-down of high pressure cleaner
- With safety pressure switch to shut down the boiler in case of lack of water
- Stainless steel vertical boiler with coil burner cooling function driven by independent motor, double coil and refractory cement bottom
- Heating boiler shut-down delay circuit
- Pressure adjustment built-in
- Fuel tank with drain plug (14 l)
- Thermostat
- Built-in detergent suction
- Built-in detergent tank capacity 6 l
- Water filter and fuel inlet filter
- Electric cable length 5 m
- Steel braided reinforced hose (10 m)

		6950	6970
		<b>HRC</b>	<b>HRR</b>
		<b>TST®</b> Total Stop SYSTEM TIMED	

MOD	COD	MAX		MAX		MAX		MAX		MAX		MAX		MAX	
		bar max	bar work	psi max	psi work	l/h work	gph work	hp	kW	kW work	rpm	Hz	V	kg	°C
6950	24103-V	180	150	2610	2175	900	238	5,5	4	5	1450	50	400 3~	94	110
6970	25276-V	230	200	3335	2900	900	238	7,5	5,5	7,4	1450	50	400 3~	98	110

### Accessori standard Standard accessories



41047 (5850)



46221



3160160  
(10 m)



3083 (6950/1505)  
3086 (6970/15045)





# 78 Series 7850.7870

IDROPULTRICI ALTA PRESSIONE  
high pressure washers

## HEAVYPRO



manico ergonomico  
ergonomic handle

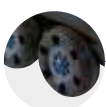

battistrada in gomma  
rubber wheels



spie: tensione, gasolio, fiamma  
termostato per regolazione  
temperatura acqua  
warning lights: power on, fuel, flame  
water temperature control thermostat



caldaia in acciaio  
Stainless steel boiler



filtro ingresso acqua  
ispezionabile  
inspectable water intake filter

### Caratteristiche Generali

- Pompa a 3 pistoni in ceramica con sistema biella-manovella
- Valvola di by-pass automatica con azzeramento della pressione nella testa della pompa
- Motore elettrico trifase con protezione termica
- Sistema di arresto totale dell'idropulitrice a distanza
- Pressostato di sicurezza per spegnimento della caldaia in caso di mancanza acqua
- Caldaia verticale in acciaio inox, con sistema di raffreddamento bruciatore a chiodi azionata da motore elettrico indipendente, doppia serpentina e fondo in cemento refrattario
- Scheda microperdite con segnalatore acustico
- Scheda di ritardo per spegnimento caldaia
- Regolazione pressione
- Serbatoio gasolio 15 l, con tappo di scarico
- Termostato
- Aspirazione detergente incorporata
- Serbatoio detergente 4/5 l incorporato
- Filtro acqua e filtro aspirazione gasolio
- Tubo rinforzato con treccia in acciaio (10 m)

### General Features

- Triplex pump with ceramic pistons and connecting rod system
- Automatic by-pass valve with pump head pressure discharge
- Heavy-duty three-phase motor with thermal protector
- Remote control for total shut-down of high pressure cleaner
- With safety pressure switch to shut down the boiler in case of lack of water
- Stainless steel vertical boiler with coil burner cooling function driven by independent motor, double coil and refractory cement bottom
- Minor leak detector PCB with buzzer
- Heating boiler shut-down delay circuit
- Pressure adjustment built-in
- Fuel tank with drain plug (15 l)
- Thermostat
- Built-in detergent suction
- Built-in detergent tank capacity 4/5 l
- Water filter and fuel inlet filter
- Steel braided reinforced hose (10 m)

	7850	7870	
	HRC	HRR	
	TST <sup>®</sup> Total Stop SYSTEM TIMED		

MOD	COD	MAX				MAX								KG	
		bar max	bar work	psi max	psi work	l/h work	gph work	hp	kW	kW work	rpm	Hz	V	kg	°C Max
7850	25277-V	180	150	2610	2175	900	238	5,5	4	5	1450	50	400 3~	94	110
7870	25278-V	230	200	3335	2900	900	238	7,5	5,5	7,4	1450	50	400 3~	98	110

### Accessori standard Standard accessories



41089



46221



3160160  
(10 m)



3083 (7850/1505)  
3086 (7870/15045)



### HEAVYPRO



manico ergonomico  
ergonomic handle



vaschetta acqua con galleggiante  
water tank with float switch



battistrada in gomma  
rubber wheels



spie: tensione, gasolio, fiamma  
termostato per regolazione  
temperatura acqua  
warning lights: power on, fuel, flame  
water temperature control thermostat



caldaia in acciaio  
Stainless steel boiler



filtro ingresso acqua  
ispezionabile  
inspectable water intake filter

### Caratteristiche Generali

- Pompa a 3 pistoni in ceramica con sistema biella-manovella
- Valvola di by-pass automatica con azzeramento della pressione nella testa della pompa
- Motore elettrico trifase con protezione termica
- Sistema di arresto totale dell'idropulitrice a distanza
- Pressostato di sicurezza per spegnimento della caldaia in caso di mancanza acqua
- Caldaia verticale in acciaio inox, con sistema di raffreddamento bruciatore a chiocciola azionata da motore elettrico indipendente, doppia serpentina e fondo in cemento refrattario
- Scheda microperdite con segnalatore acustico
- Scheda di ritardo per spegnimento caldaia
- Regolazione pressione
- Serbatoio gasolio 24 l, con tappo di scarico
- Termostato
- Aspirazione detergente incorporata
- Serbatoio detergente 8 l incorporato
- Filtro acqua e filtro aspirazione gasolio
- Tubo rinforzato con doppia treccia in acciaio (10 m)

### General Features

- Triplex pump with ceramic pistons and connecting rod system
- Automatic by-pass valve with pump head pressure discharge
- Heavy-duty three-phase motor with thermal protector
- Remote control for total shut-down of high pressure cleaner
- With safety pressure switch to shut down the boiler in case of lack of water
- Stainless steel vertical boiler with coil burner cooling function driven by independent motor, double coil and refractory cement bottom
- Minor leak detector PCB with buzzer
- Heating boiler shut-down delay circuit
- Pressure adjustment built-in
- Fuel tank with drain plug (24 l)
- Thermostat
- Built-in detergent suction
- Built-in detergent tank capacity 8 l
- Water filter and fuel inlet filter
- Double steel braided reinforced hose (10 m)

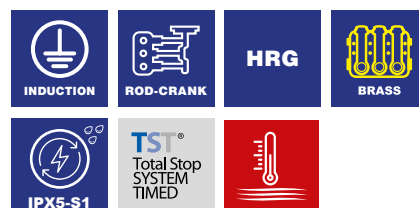

MOD	COD	MAX				MAX								KG NET		
		bar max	bar work	psi max	psi work	l/h work	gph work	hp	kW	kW work	rpm	Hz	V	kg	°C Max	
8840	22913-V	180	150	2610	2175	1260	333	7,5	5,5	7,4	1450	50	400 3~	135	110	
8860	22914-V	230	200	3335	2900	1260	333	9,6	7	9,3	1450	50	400 3~	135	110	
8880	22915-V	280	250	4060	3625	900	238	10	7,5	9,3	1450	50	400 3~	135	110	

### Accessori standard Standard accessories



41089



50690



3160170  
(10 m)



3157 (8840/1508)  
3084 (8860/1506)  
3082 (8880/1504)



# 13 Series 1310.1320.1325

IDROPULTRICI ALTA PRESSIONE  
high pressure washers

## HEAVYPRO



quadro comandi  
bassa tensione  
low voltage  
control panel

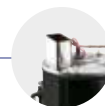

caldaia in acciaio  
Stainless steel boiler



porta accessori  
built-in accessories  
holder



filtro ingresso acqua ispezionabile  
inspectable water intake filter



battistrada in  
gomma  
rubber wheels



### Caratteristiche Generali

- Struttura robusta con cofano in acciaio inox (AISI 430)
- Pompa a 3 pistoni in ceramica con sistema biella-manovella
- Testa pompa in ottone
- Valvola di by-pass automatica
- Motore elettrico monofase
- Protezione motore magnetotermica
- Total Stop Temporizzato
- Arresto per microperdite
- Arresto dopo 1 ora di Total Stop
- Arresto per mancanza d'acqua
- Arresto per surriscaldamento motore
- Segnalazione d'errore tramite spia intermittente
- Regolazione pressione
- Quadro comandi a bassa tensione
- Spie presenza corrente, gasolio e TST
- Quadro comandi in inox (AISI 430)
- 3 pressostati a 24 V
- Caldaia inox (AISI 430)
- Aspirazione detergente incorporata
- Serbatoio gasolio 24 l
- Pistola con swivel
- Tubo rinforzato con treccia in acciaio (8/10 m)

### General Features

- Heavy-duty frame with stainless steel cover (AISI 430)
- Triplex pump with ceramic pistons and connecting rod system
- Brass pump head
- Automatic by-pass valve
- Heavy-duty one-phase motor
- Magnetothermal motor overload cutout
- Time delayed auto stop/start
- Stop for leak detention
- Stop after 1 hour of total stop
- Stop for lack of water
- Stop for motor overloading
- System error warning light
- Pressure adjustment
- Low voltage control panel
- Power on, fuel level and TST lights
- Stainless steel control panel
- 3 Pressure switches at 24V
- Stainless steel boiler (AISI 430)
- Integral detergent suction
- Fuel tank 24 l
- Gun with swivel
- Steel braided reinforced hose

1310

1320.1325

HPV-O

HRC



INDUCTION



ROD-CRANK



BRASS



IPX5-S1



TST<sup>®</sup>  
Total Stop  
SYSTEM  
TIMED



MOD	COD	MAX		MAX		MAX		MAX		MAX		MAX		MAX	
		bar max	bar work	psi max	psi work	l/h work	gph work	hp	kW	kW work	rpm	Hz	V	kg	°C Max
1310	24894-V	150	130	2200	1885	500	133	2,5	1,8	2,5	2800	50	230~	105	100
1320	25273-V	150	120	2175	1740	600	159	3	2,2	3	1450	50	230~	110	100
1325	25274-V	180	150	2610	2175	900	238	5	3,7	5	2800	50	400 3~	110	100

### Accessori standard Standard accessories



47029



46221



3164640 (1310/8 m)  
3160590 (1320.1325/10 m)



3104 (1310/1503)  
3082 (1320.1504)  
3095 (1325.15055)

A richiesta  
on request

versione con ruota  
posteriore pivotante  
rear castor wheel  
version



# 13 Series 1380

IDROPULTRICI ALTA PRESSIONE  
high pressure washers



## HEAVYPRO



quadro comandi  
bassa tensione  
low voltage  
control panel



filtro ingresso acqua ispezionabile  
inspectable water intake filter



caldaia in acciaio  
Stainless steel boiler



porta accessori  
built-in accessories  
holder



battistrada in  
gomma  
rubber wheels

### Caratteristiche Generali

- Struttura robusta con cofano in acciaio inox (AISI 430)
- Pompa a 3 pistoni in ceramica con sistema biella-manovella
- Valvola di by-pass automatica
- Motore elettrico trifase
- Protezione motore magnetotermica
- Arresto per microperdite
- Arresto dopo 1 ora di Total Stop
- Arresto per mancanza d'acqua
- Arresto per surriscaldamento motore
- Segnalazione d'errore tramite spia intermittente
- Regolazione pressione
- Quadro comandi a bassa tensione
- Spie presenza corrente, gasolio e TST
- Quadro comandi in inox (AISI 430)
- 3 pressostati a 24 V
- Caldaia inox (AISI 430)
- Aspirazione detergente incorporata
- Serbatoio gasolio 24 l
- Pistola con swivel
- Tubo rinforzato con treccia in acciaio (10 m)

### General Features

- Heavy-duty frame with stainless steel cover (AISI 430)
- Triplex pump with ceramic pistons and connecting rod system
- Automatic by-pass valve
- Heavy-duty three-phase motor
- Magnetothermal motor overload cutout
- Time delayed auto stop/start
- Stop for leak detention
- Stop after 1 hour of total stop
- Stop for lack of water
- Stop for motor overloading
- System error warning light
- Pressure adjustment
- Low voltage control panel
- Power on, fuel level and TST lights
- Stainless steel control panel
- 3 Pressure switches at 24V
- Stainless steel boiler (AISI 430)
- Integral detergent suction
- Fuel tank 24 l
- Gun with swivel
- Steel braided reinforced hose

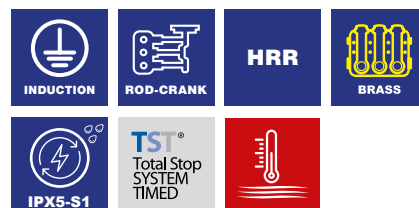

MOD	COD	MAX		MAX		MAX		MAX		MAX		MAX		MAX	
		bar max	bar work	psi max	psi work	l/h work	gph work	hp	kW	kW work	rpm	Hz	V	kg	°C
1380	25284-V	230	200	3335	2900	900	238	7,5	5,5	7,4	1450	50	400 3~	150	110

### Accessori standard Standard accessories



A richiesta  
on request

versione con ruota  
posteriore pivotante  
rear castor wheel  
version



**ACCESSORI**













*Accessories*





		25 Series	35 Series	45 Series		58 Series	66 Series	69 Series	78 Series	88 Series		13 Series										
		2591	3590	4590	5670	5850	5870	6640	6670	6950	6970	7850	7870	8840	8860	8880	1310	1320	1325	1380		
Pistola Trigger gun		41047	S	S	S	S																
		42709															S	S	S			
		41089						S	S	S	S	S	S	S	S	S						
		47684																		S		
		41847					S															
Lancia con testina fissa senza ugello <i>Lance with fixed head w/out nozzle</i>		50690 (56 cm)	S	S	S									S	S	S						
Lancia con testina alta/ bassa press. senza ugello <i>Lance with high/ low pressure head w/out nozzle</i>		46221 (56 cm)				S	S	S	S	S	S	S	S				S	S	S	S		
Ugelli Wash nozzles 1/4 MEG		3729 (15025)	S	S																		
		3104 (1503)			S	S												S				
		3082 (1504)					S	S									S		S			
		3086 (15045)							S	S	S										S	
		3083 (1505)								S	S											
		3095 (15055)						S												S		
		3084 (1506)													S							
		3157 (1508)													S							
		Lancia getto rotante PRO <i>Rotary lance PRO</i>		40898 (56 cm)	O	O																
				41050 (56 cm)			O	O													O	
40964 (56 cm)							O	O											O	O		
40803 (56 cm)									O	O	O										O	
40965 (56 cm)							O								O					O		
40966 (56 cm)									O	O												
40969 (56 cm)															O							
3164470 (8 m) Reinforced				S	S	S	S	S										S				
Tubo AP Hose HP		3160160 (10 m) Reinforced					S	S	S	S	S	S	S									
		3160170 (10 m) Reinforced												S	S	S						
		3160590 (10m) Reinforced																	S	S	S	
Prolunga tubo AP Reinforced extension HP hose		40641 (15 m)	O	O	O	O	O										O					
		40106 (15 m)					O	O	O	O	O	O	O	O	O	O			O	O	O	

Legenda: "S" Accessorio di serie - "O" Accessorio opzionale  
"S" On board accessory - "O" Optional accessory

		25 Series	35 Series	45 Series		58 Series	66 Series	69 Series	78 Series	88 Series	13 Series									
		2591	3590	4590	5670	5850	5870	6640	6670	6950	6970	7850	7870	8840	8860	8880	1310	1320	1325	1380
Kit schiumogeno Foam lance bottle *		40320	S	S	S															
Kit schiumogeno alta pressione High pressure foam lance bottle *		41552	O	O	O	O	O	O	O	O	O	O	O	O	O	O	O	O	O	O
		1272520 (8 m)	O	O	O	O	O	O	O	O	O	O	O	O	O	O	O	O	O	O
		1272530 (16 m)	O	O	O	O	O	O	O	O	O	O	O	O	O	O	O	O	O	O
		46365 (10 m) *													O					
		46367 (16 m) *													O					
Spazzola fissa Fixed brush *		41577	O	O	O	O														
		41578	O	O	O	O														
Spazzola rotante Rotary brush *		46370				O	O	O	O	O	O	O	O	O	O	O	O	O	O	O
		46371												O						
Lavapavimenti con serbatoio detergente d. 30 cm Patio cleaner with detergent tank d. 30 cm *		41687	O	O	O	O														
Lavapavimenti d. 30 cm Patio cleaner d. 30 cm *		46359	O	O	O	O														
Lavapavimenti PRO con regolazione Patio cleaner PRO with pressure adjustment *		46368	O	O	O	O											O			
		46369					O	O		O	O	O	O		O			O	O	O
Kit lancia sabbiante PRO Sand blasting lance PRO *		41591 (50 cm)	O	O	O	O											O			
		41762 (50 cm)					O	O		O	O	O	O		O			O		O
		41763 (50 cm)					O	O	O		O	O	O	O	O				O	

(\* Utilizzare solo con acqua fredda  
(\*) Use cold water only

Legenda: "S" Accessorio di serie - "O" Accessorio opzionale  
"S" On board accessory - "O" Optional accessory

		25 Series	35 Series	45 Series		58 Series	66 Series	69 Series	78 Series	88 Series	13 Series									
		2591	3590	4590	5670	5850	5870	6640	6670	6950	6970	7850	7870	8840	8860	8880	1310	1320	1325	1380
Sabbia calibrata e filtrata <i>Calibrated filtered sand *</i>		3207 (5 kg)	O	O	O	O	O	O	O	O	O	O	O	O	O	O	O	O	O	O
		41770 (25 kg)	O	O	O	O	O	O	O	O	O	O	O	O	O	O	O	O	O	O
Kit aspirazione acqua <i>Water suction kit *</i>		41592	O	O	O	O	O	O	O	O	O	O	O			O	O	O	O	O
		46374 (15025 - 75 cm)	O	O																
Kit lancia sottoscocca con ugello <i>Underbody lance with nozzle *</i>		41590 (1503 - 80 cm)		O	O												O			
		41751 (1504 - 80 cm)				O		O								O		O		
		46372 (15045 - 80 cm)							O		O		O							
		41753 (1505 - 80 cm)								O		O								
		46373 (1506 - 80 cm)						O							O					O
		41754 (1508 - 80 cm)												O						
Lancia senza ugello <i>Lance w/out nozzle</i>		40652 (90 cm)	O	O	O	O	O	O	O	O	O	O	O	O	O	O	O	O	O	O
		40653 (120 cm)	O	O	O	O	O	O	O	O	O	O	O	O	O	O	O	O	O	O
		40654 (150 cm)	O	O	O	O	O	O	O	O	O	O	O	O	O	O	O	O	O	O
		40694 (170 cm)	O	O	O	O	O	O	O	O	O	O	O	O	O	O	O	O	O	O
		40695 (200 cm)	O	O	O	O	O	O	O	O	O	O	O	O	O	O	O	O	O	O
Lancia doppia <i>Double lance</i>		3160620 (66 cm)	O	O	O	O	O	O	O	O	O	O	O	O	O	O	O	O	O	O
Ugello bassa pressione <i>Low pressure nozzle</i>		3251 (2525)	O	O	O	O	O	O	O	O	O	O	O	O	O	O	O	O	O	O
Testina doppio ugello <i>Roller nozzle</i>		3025	O	O	O	O	O	O	O	O	O	O	O	O	O	O	O	O	O	O
Ugello a vapore <i>Steam nozzle</i>		50250	O	O	O	O	O	O	O	O	O	O	O	O	O	O	O	O	O	O
Kit filtro acqua <i>Water filter kit</i>		41593	O	O	O	O	O	O	O	O	O	O	O	O	O	O	O	O	O	O
Kit attacco rapido <i>Click fast kit</i>		41580	O	O	O	O	O	O	O	O	O	O	O	O	O	O	O	O	O	O
Kit attacco rapido ottone <i>Brass click fast kit</i>		40439	O	O	O	O	O	O	O	O	O	O	O	O	O	O	O	O	O	O
Kit RLW senza tubo <i>Hose reel kit w/out hose</i>		42660	O	O	O															
		40839						O	O											
		40840								O	O	O	O	O	O	O				

Legenda: "S" Accessorio di serie - "O" Accessorio opzionale  
"S" On board accessory - "O" Optional accessory







CLEANING **DIVISION**

# VACUUM CLEANERS HOME

Compatti ma estremamente potenti e versatili. Studiati anche per la pulizia di piccoli spazi, gli aspiratori multiuso AR BLUE CLEAN sono la soluzione ideale per diversi tipi di sporco, sia esso solido e liquido. Rumorosità controllata e accessori pratici sono gli ingredienti perfetti per prenderti cura degli spazi a te più cari con estrema praticità.

*Compact but extremely powerful and versatile. Designed for cleaning even small spaces, AR BLUE CLEAN multi-purpose vacuum cleaners are the ideal solution for different types of both solid and liquid dirt. Controlled noise levels and handy accessories are the perfect ingredients for taking care of the spaces you love with the greatest of ease.*



# Applicazioni ed indicatori di prestazioni Aspirapolveri Home

## *Vacuum Cleaners Home performance Indicators & Applications*

### BLUE CLEAN LEVEL

**BLUE CLEAN LEVEL A**  
Frequenza utilizzo: occasionale  
Superficie mq: piccole superfici  
Intensità sporco: sporco superficiale  
*Frequency of use: occasional  
Surface m<sup>2</sup>: small surfaces  
Dirt intensity: superficial dirt*

**BLUE CLEAN LEVEL B**  
Frequenza utilizzo: occasionale  
Superficie mq: piccole/medie superfici 20/40 m<sup>2</sup>  
Intensità sporco: pulizia profonda di sporco superficiale  
*Frequency of use: occasional  
Surface m<sup>2</sup>: small/medium surfaces 20/40 m<sup>2</sup>  
Dirt intensity: in-depth removal of superficial dirt*

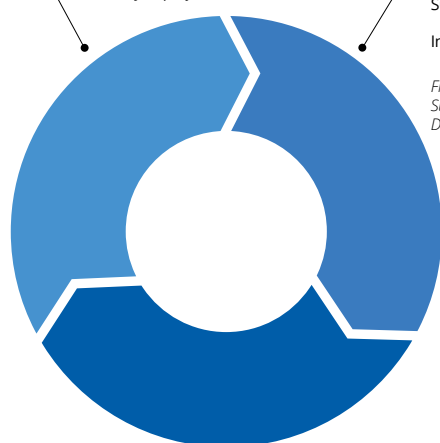

**BLUE CLEAN LEVEL C**  
Frequenza utilizzo: quasi frequente  
Superficie mq: medie superfici 40/60 m<sup>2</sup>  
Intensità sporco: sporco resistente  
*Frequency of use: almost frequent  
Surface m<sup>2</sup>: medium surfaces 40/60 m<sup>2</sup>  
Dirt intensity: stubborn dirt*

**BLUE CLEAN LEVEL** ti guida nella scelta del prodotto migliore, in base ad ogni esigenza di pulizia, affiancando ad ogni idropulitrice o aspiratore un'icona di livello lavaggio, insieme con le applicazioni. Ogni prodotto ha le sue caratteristiche tecniche ma anche estetiche-funzionali per soddisfare specifiche necessità del cliente, come la facilità d'uso, la compattezza, l'ergonomia, il peso, la rumorosità e la manovrabilità. Grazie al Blue Clean Level suggeriamo ad ogni cliente la combinazione migliore: è per questo che i prodotti ARBC fanno la differenza.

**BLUE CLEAN LEVEL** guides you in the choice of the best products for all cleaning needs, by placing a cleaning level icon next to every high pressure washer or vacuum cleaner, together with its applications. Every product has its own technical, stylistic and functional characteristics, to satisfy specific customer requirements, such as ease of use, compact size, labour-saving, weight, noise output and agility. With Blue Clean Level we direct every customer towards the ideal combination: this is why ARBC products make a real different.

### BLUE CLEAN FACTOR



La combinazione ideale tra prestazioni tecniche e configurazione commerciale per poter risolvere al meglio le tue esigenze di pulizia. I prodotti che hanno il BLUE FACTOR sono i migliori, all'interno della loro categoria, per poter pulente, facilità d'utilizzo e prestazioni tecniche. Il mix perfetto per ogni tua esigenza di pulizia.

*The ideal combination of technical features and commercial configuration, to deliver the best solution to your cleaning needs. Products with the BLUE FACTOR are best-in-class in cleaning power, ease of use and technical performances. The perfect mix for all your cleaning requirements.*

# VACUUM HOME APPLICATIONS



**liquidi** fluids  
**grandi volumi** big volumes  
**interni** houses  
**cantine** cellars  
**soffitte** lofts



**autorimesse** garages  
**balconi** balcony  
**cucchie** dog house, kennels  
**piccoli cantieri** little work sites  
**veicoli** cars



**poltrone divani** armchairs couches  
**spazi ristretti** limited spaces  
**stufe** heaters  
**camini** fireplaces  
**griglie** grills

La gamma di aspiratori per solidi e liquidi AR BLUE CLEAN è un pratico alleato per aiutarti a mantenere la casa pulita. Dal design compatto, ma con motori potenti, sono la soluzione ideale per aspirare perfettamente qualsiasi tipo di sporco anche in piccoli spazi.

I numerosi accessori, che completano l'offerta di prodotto, permettono di pulire tutte le superfici in modo veloce, pratico e con risultati eccezionali.

*The AR BLUE CLEAN range of handy solid/liquid vacuum cleaners give you practical assistance in keeping your home clean. Compact design for multi-purpose vacuum cleaners, ideal even for small spaces but with powerful motors for thorough cleaning of even the most stubborn dirt.*

*With the accessories that complete our product offering, you can clean all surfaces quickly, easily and with outstanding results.*

<b>31 Series</b> 3170	●		●	●	●	●					●	●	●		
<b>32 Series</b> 3270	●		●	●	●	●					●	●	●		
<b>33 Series</b> 3370	●		●	●	●	●					●	●			
<b>36 Series</b> 3670	●		●	●	●	●					●	●			
<b>37 Series</b> 3770	●		●	●	●	●					●	●			
<b>37 Series</b> 3780	●	●	●	●	●	●	●	●	●	●	●				
<b>Eco Series</b> E12														●	●
<b>Eco Series</b> M20	●		●	●	●	●	●	●	●	●	●	●	●	●	●



# 31 Series 3170

ASPIRATORI SOLIDI LIQUIDI  
wet & dry vacuum cleaners

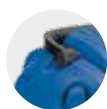

funzione soffiante  
blower function



cerniere aggancio/sgancio  
rapido per pulizia filtri e fusto  
quick connection/release hinges  
for filter and tank cleaning



fusto raccolta in materiale plastico  
plastic tank



4 ruote pivotanti e stabili  
4 stable castor wheels

## Caratteristiche Generali

- Aspiratore per liquidi e polveri
- Fusto raccolta in materiale plastico robusto e resistente
- Tubo d'aspirazione flessibile e resistente alla torsione
- Portaccessori integrato
- Posizione parcheggio durante le soste di lavoro
- Gancio per rimessaggio cavo d'alimentazione
- Galleggiante per interrompere l'aspirazione quando il fusto è pieno
- Cerniere aggancio-sgancio rapido per pulizia filtri e fusto
- Funzione soffiante

## General Features

- Wet & Dry vacuum cleaner
- Tough, sturdy plastic tank
- Flexible, kink-resistant suction hose
- Integral accessories carrier
- Parking position for use during breaks in work
- Hook for stowing power supply cable
- Float switch to cut out suction when tank is full
- Quick connection/release hinges for filter and tank cleaning
- Blower function
- Washable high efficiency filter



MOD	COD					
		K <sup>PA</sup>	l/s	W <sub>(MAX)</sub>	Hz	V
3170	51922-V	17	28	1200	50-60	220-240~



dB(A)  
73,6



l  
15



kg  
5.7

## Accessori standard Standard accessories



4340150

4340170

4341870  
(1,5 m)



4340200



46315\*



46259\*  
(15 l)

(\* 1 pezzo in dotazione  
\*) 1 piece supplied



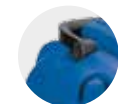

funzione soffiante  
blower function



cerniere aggancio/sgancio  
rapido per pulizia filtri e fusto  
quick connection/release hinges  
for filter and tank cleaning



fusto raccolto in materiale plastico  
plastic tank



4 ruote pivotanti e stabili  
4 stable castor wheels

### Caratteristiche Generali

- Aspiratore per liquidi e polveri
- Fusto raccolto in materiale plastico robusto e resistente
- Tubo d'aspirazione flessibile e resistente alla torsione
- Portaccessori integrato
- Posizione parcheggio durante le soste di lavoro
- Gancio per rimessaggio cavo d'alimentazione
- Galleggiante per interrompere l'aspirazione quando il fusto è pieno
- Cerniere aggancio-sgancio rapido per pulizia filtri e fusto
- Funzione soffiante

### General Features

- Wet & Dry vacuum cleaner
- Tough, sturdy plastic tank
- Flexible, kink-resistant suction hose
- Integral accessories carrier
- Parking position for use during breaks in work
- Hook for stowing power supply cable
- Float switch to cut out suction when tank is full
- Quick connection/release hinges for filter and tank cleaning
- Blower function
- Washable high efficiency filter



MOD	COD					
		K <sup>PA</sup>	l/s	W <sub>(MAX)</sub>	Hz	V
3270	51923-V	17	28	1200	50-60	220-240~



**dB(A)**

73,6



**l**

20



**kg**

6.1

### Accessori standard Standard accessories



4340150

4340170

4341870  
(1,5 m)



4340200



46262\*



46260\*  
(20 l)

(\* 1 pezzo in dotazione  
(\* 1 piece supplied)



# 33 Series 3370

ASPIRATORI SOLIDI LIQUIDI  
wet & dry vacuum cleaners



funzione soffiante  
*blower function*



cerniere aggancio/sgancio  
rapido per pulizia filtri e fusto  
*quick connection/release hinges for  
filter and tank cleaning*



fusto raccolta in acciaio inox  
*stainless steel tank*



4 ruote pivotanti e stabili  
*4 stable castor wheels*

## Caratteristiche Generali

- Aspiratore per liquidi e polveri
- Fusto raccolta in acciaio inossidabile
- Tubo d'aspirazione flessibile e resistente alla torsione
- Portaccessori integrato
- Posizione parcheggio durante le soste di lavoro
- Gancio per rimessaggio cavo d'alimentazione
- Galleggiante per interrompere l'aspirazione quando il fusto è pieno
- Cerniere aggancio-sgancio rapido per pulizia filtri e fusto
- Funzione soffiante
- Filtro alta efficienza lavabile

## General Features

- Wet & Dry vacuum cleaner
- Stainless steel tank
- Flexible, kink-resistant suction hose
- Integral accessories carrier
- Parking position for use during breaks in work
- Hook for stowing power supply cable
- Float switch to cut out suction when tank is full
- Quick connection/release hinges for filter and tank cleaning
- Blower function
- Washable high efficiency filter



MOD	COD					
		K <sup>PA</sup>	l/s	W <sub>(MAX)</sub>	Hz	V
3370	51924-V	18	33	1400	50-60	220-240~



dB(A)	l	kg
73,6	20	6.3

## Accessori standard Standard accessories



4340150

4340170

4341310  
(2 m)



4340200



46263



46257\*  
(20 l)

(\* ) 1 pezzo in dotazione  
(\* ) 1 piece supplied



funzione soffiante  
*blower function*



cerniere aggancio/sgancio  
rapido per pulizia filtri e fusto  
*quick connection/release hinges  
for filter and tank cleaning*



fusto raccolta in acciaio inox  
*stainless steel tank*

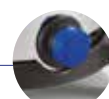

tappo di scarico  
*plug for draining*



4 ruote pivotanti e stabili  
*4 stable castor wheels*

### Caratteristiche Generali

- Aspiratore per liquidi e polveri
- Fusto raccolta in acciaio inossidabile
- Tubo d'aspirazione flessibile e resistente alla torsione
- Portaccessori integrato
- Posizione parcheggio durante le soste di lavoro
- Gancio per rimessaggio cavo d'alimentazione
- Galleggiante per interrompere l'aspirazione quando il fusto è pieno
- Cerniere aggancio-sgancio rapido per pulizia filtri e fusto
- Funzione soffiante
- Tappo di scarico liquidi per svuotamento fusto
- Filtro alta efficienza lavabile

### General Features

- Wet & Dry vacuum cleaner
- Stainless steel tank
- Flexible, kink-resistant suction hose
- Integral accessories carrier
- Parking position for use during breaks in work
- Hook for stowing power supply cable
- Float switch to cut out suction when tank is full
- Quick connection/release hinges for filter and tank cleaning
- Blower function
- Plug for draining liquids from tank
- Washable high efficiency filter



MOD	COD					
3670	51927-V	19	37	1600	50-60	220-240~

### Accessori standard Standard accessories



73,6	30	6.5

(\* 1 pezzo in dotazione  
(\* 1 piece supplied)



# 37 Series 3770

ASPIRATORI SOLIDI LIQUIDI  
wet & dry vacuum cleaners



cerniere aggancio/  
sgancio rapido per  
pulizia filtri e fusto  
*quick connection/release  
hinges for filter and tank  
cleaning*



4 ruote pivotanti e stabili  
*4 stable castor wheels*



presa elettroutensile con avvio  
automatico START/STOP  
*power tool socket with automatic START/STOP*



fusto raccolta in materiale plastico  
*plastic tank*

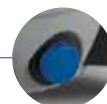

tappo per scarico liquidi  
*cap for drain service*

## Caratteristiche Generali

- Tipologia filtro: filtro alta efficienza + 1 sacchetto filtro carta
- N.4 ruote pivotanti
- Galleggiante per interrompere l'aspirazione quando il fusto è pieno
- Cerniere aggancio/sgancio rapido per pulizia filtri e fusto
- Posizione parcheggio durante le soste di lavoro
- Gancio per rimessaggio cavo d'alimentazione
- Funzione soffiante
- Funzione drenante
- Porta accessori integrato
- Resistente fusto di raccolta in plastica
- Tubo d'aspirazione resistente alla torsione

## General Features

- Main filter type: High efficiency cartridge filter + 1 paper bag
- N.4 castor wheels
- Float switch to cut out suction when tank is full
- Quick connection/release hinges for filter and tank cleaning
- Parking position for use during breaks in work
- Power supply cable storage hook
- Blower function
- Drain system
- Built-in accessory holder
- Sturdy plastic tank
- Kink-resistant suction hose



MOD	COD					
		K <sup>PA</sup>	l/s	W(MAX)	Hz	V
3770	51928-V	19	39	1600	50-60	220-240~

°Potenza massima utensile 1600 W  
Tool max power 1,600 W

dB(A)	l	kg
73,6	35	10.3

## Accessori standard Standard accessories



(\*) 1 pezzo in dotazione  
(\* 1 piece supplied)



cerniere aggancio/  
sgancio rapido per  
pulizia filtri e fusto  
*quick connection/release  
hinges for filter and tank  
cleaning*



2 ruote posteriori  
ø18cm per  
una maggiore stabilità  
*2 rear wheels ø18cm for  
greater stability*



tappo per scarico liquidi  
*cap for drain service*

# 4 in 1



maniglia in metallo per agevolare  
i movimenti  
*easy-to-use metal handle*



presa elettroutensile con  
avvio automatico START/STOP  
*power tool socket with  
automatic START/STOP*



fusto raccolto in acciaio inox  
*stainless steel tank*



### Caratteristiche Generali

- Tipologia filtro: filtro alta efficienza + 1 sacchetto filtro carta
- N.2 ruote anteriori pivotanti
- Galleggiante per interrompere l'aspirazione quando il fusto è pieno
- Cerniere aggancio/sgancio rapido per pulizia filtri e fusto
- Posizione parcheggio durante le soste di lavoro
- Gancio per rimessaggio cavo d'alimentazione
- Funzione soffiante
- Funzione drenante
- Porta accessori integrato
- Resistente fusto di raccolta in acciaio inox
- Tubo d'aspirazione resistente alla torsione

### General Features

- Main filter type: High efficiency cartridge filter + 1 paper bag
- N.2 front castor wheels
- Float switch to cut out suction when tank is full
- Quick connection/release hinges for filter and tank cleaning
- Parking position for use during breaks in work
- Power supply cable storage hook
- Blower function
- Drain system
- Built-in accessory holder
- Stainless steel tank
- Kink-resistant suction hose



MOD	COD					
		K <sup>PA</sup>	l/s	W(MAX)	Hz	V
3780	51929-V	19	41	1600	50-60	220-240~

◊ Potenza massima utensile 1600 W  
*Tool max power 1,600 W*

dB(A)	l	kg
73,6	50	12.7

### Accessori standard Standard accessories



**(\*) 1 pezzo in dotazione**  
*(\*) 1 piece supplied*



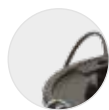

cerniere aggancio/sgancio rapido in metallo per pulizia fusto  
quick connection/release metal hinges for filter and tank cleaning

# 2 in 1



fusto raccolta in metallo  
metal tank

### Caratteristiche Generali

- Aspiratore per le ceneri fredde di camini, stufe e barbecue
- Cerniere aggancio/sgancio rapido in metallo per pulizia filtro e fusto
- Fusto in acciaio
- Filtro ad alta efficienza plissettato e lavabile con protezione metallica
- Maniglia integrata
- Lunghezza cavo elettrico 1,2 m

### General Features

- Fireplace, stove and barbecue cold ash vacuum cleaner
- Quick connection/release metal hinges for filter and tank cleaning
- Steel plate tank
- High-efficiency pleated and washable filter with metal guard
- Built-in handle
- Power cord length 1,2 m



MOD	COD							
		K <sup>PA</sup>	l/s	W(MAx)	Hz	V	I	kg
E12	52445	11	21	600	50	230~	12	2,5



### Accessori standard Standard accessories



5060120

5060130  
(1 m)

5060070



funzione soffiante  
blower function



fusto raccolta in  
acciaio inox  
stainless steel tank



cerniere aggancio/sgancio  
rapido per pulizia filtri e fusto  
quick connection/release hinges  
for filter and tank cleaning



4 ruote pivotanti e stabili  
4 stable castor wheels



### Caratteristiche Generali

- Aspiratore per ceneri, liquidi e polveri
- Fusto raccolta in acciaio inossidabile
- Tubo d'aspirazione flessibile e resistente alla torsione
- Tubo aspirazione flessibile in metallo rivestito per ceneri
- Portaccessori integrato
- Posizione parcheggio durante le soste di lavoro
- Gancio per rimessaggio cavo d'alimentazione
- Galleggiante per interrompere l'aspirazione quando il fusto è pieno
- Cerniere aggancio-sgancio rapido per pulizia filtri e fusto
- Funzione soffiante
- Filtro alta efficienza lavabile
- Cavo elettrico di 5 metri

### General Features

- Ash, Wet & Dry vacuum cleaner
- Stainless steel tank
- Flexible, kink-resistant suction hose and Metal coated flexible suction hose for ash
- Integral accessories carrier
- Parking position for use during breaks in work
- Hook for stowing power supply cable
- Float switch to cut out suction when tank is full
- Quick connection/release hinges for filter and tank cleaning
- Blower function
- Washable high efficiency filter
- 5 m power cord



MOD	COD					
		K <sup>PA</sup>	l/s	W(MAX)	Hz	V
M20	52013	17	28	1200	50-60	220-240~

dB(A)	l	kg
73,6	20	7,2

### Accessori standard Standard accessories



(\*) 1 pezzo in dotazione  
(\* 1 piece supplied)

CLEANING **DIVISION**

# VACUUM CLEANERS PRO

Gamma tecnicamente progettata per l'aspirazione di liquidi e solidi, utilizzata quotidianamente dai migliori professionisti ed artigiani. Silenziosi e pratici raccolgono con estrema facilità lo sporco, lasciando le superfici di lavoro pulite e l'ambiente circostante sano.

*Range engineered for the vacuum cleaning of liquids and solids, used everyday by top professionals and craftsmen. Quiet and convenient, they pick up dirt effortlessly, leaving work surfaces clean and the surrounding environment healthy.*



# Applicazioni ed indicatori di prestazioni PRO

## *PRO performance Indicators & Applications*

### BLUE CLEAN PRO LEVEL

#### ○ LIGHTPRO

Fascia di aspiratori progettati per utilizzatori esperti che hanno necessità di eseguire lavori di pulizia che richiedono una buona capacità aspirante.

*Vacuum cleaner category designed for skilled users tackling cleaning jobs operations which need plenty of good suction capacity.*

#### ● HEAVYPRO

Fascia di aspiratori progettati per professionisti che hanno necessità di eseguire lavori di pulizia che richiedono massime prestazioni.

*Vacuum cleaner category designed for professionals, dealing with cleaning jobs that need the very highest-performing appliances.*

### BLUE CLEAN FACTOR



La combinazione ideale tra prestazioni tecniche e configurazione commerciale per poter risolvere al meglio le tue esigenze di pulizia. I prodotti che hanno il BLUE FACTOR sono i migliori, all'interno della loro categoria, per poter pulente, facilità d'utilizzo e prestazioni tecniche. Il mix perfetto per ogni tua esigenza di pulizia.

*The ideal combination of technical features and commercial configuration, to deliver the best solution to your cleaning needs. Products with the BLUE FACTOR are best-in-class in cleaning power, ease of use and technical performances. The perfect mix for all your cleaning requirements.*



## PROFESSIONAL APPLICATIONS



artigianato  
crafts



car wash



automotive

Aspiratori per solidi e liquidi con fusto in acciaio inox oppure in robusto polipropilene ideali per la pulizia dello sporco più intenso e per cui è richiesta una maggiore capacità di raccolta. Estremamente manovrabili e di facile utilizzo, garantiscono prestazioni calibrate su misura alle esigenze dei diversi clienti professionisti.

Ottimi per il lavoro quotidiano delle imprese di pulizia e di piccole imprese di artigiani, gli aspiratori della gamma ARBC PRO sono stati progettati per aspirare grosse quantità di sporco grossolano e liquido. I numerosi accessori professionali di cui sono dotati ne migliorano le prestazioni e ne rendono ancora più agevole l'utilizzo.

*Vacuum cleaners with stainless steel or rugged polypropylene tank, ideal for tackling the dirtiest locations and when greater collection capacity is required. Very agile and easy to use, the ARBC PRO range of vacuum cleaners guarantees performances tailored to the needs of the various kinds of professional customers.*

*The solid-liquid vacuum cleaners in this range are designed to collect large quantities of coarse dirt and liquids. Excellent for everyday use by cleaning contractors and small craft workshops.*

*All products in this range come complete with professional accessories included in the pack, to improve their performance and make them even easier and more convenient to use.*



<b>41 Series</b>				
4100		●		
<b>42 Series</b>				
4200		●		
4200P		●		
<b>43.44 Series</b>				
4300MP		●	●	●
4400MP		●	●	●
4300P		●	●	●
4400P		●	●	●
4300		●	●	●
4400		●	●	●
<b>47 Series</b>				
4700S		●		
<b>48 Series</b>				
4800		●		
<b>42L Series</b>				
4200L		●	●	●
<b>43L Series</b>				
4300L		●	●	●
<b>49 Series</b>				
4900		●		



# 41 Series 4100

ASPIRATORI SOLIDI LIQUIDI  
wet & dry vacuum cleaners

## OLIGHTPRO



### Caratteristiche Generali

- Modello professionale compatto dedicato all'aspirazione di polveri e liquidi
- Fusto in acciaio inox
- Motore bi-stadio
- Ideale per la pulizia in spazi ridotti
- Galleggiante per interrompere l'aspirazione quando il fusto è pieno
- Cerniere aggancio/sgancio rapido per pulizia filtri e fusto
- Tubo d'aspirazione resistente alla torsione
- Ruote pivotanti
- Porta accessori integrato

### General Features

- Professional dust and liquid vacuum cleaner
- Stainless steel body
- Two-stage motor
- Ideal for cleaning in tight spaces
- Float switch to cut out suction when tank is full
- Quick connection/release hinges for filter and tank cleaning
- Kink-resistant suction hose
- Pivoting wheels
- Built-in accessory holder



MOD	COD							
		K <sup>P</sup> A	l/s	STADI STAGES	W(Max)	W	Hz	V
4100	50180	22,1	47,2	2	1250	1100	50	230~

dB(A)	l	kg
60	20	11

### Accessori standard Standard accessories



## OLIGHTPRO



### Caratteristiche Generali

- Modello professionale compatto dedicato all'aspirazione di polveri e liquidi
- Fusto in acciaio inox
- Motore bi-stadio
- Ideale per la pulizia in spazi ridotti
- Galleggiante per interrompere l'aspirazione quando il fusto è pieno
- Cerniere aggancio/sgancio rapido per pulizia filtri e fusto
- Tubo d'aspirazione resistente alla torsione
- Ruote pivotanti
- Porta accessori integrato

### General Features

- Professional dust and liquid vacuum cleaner
- Stainless steel body
- Two-stage motor
- Ideal for cleaning in tight spaces
- Float switch to cut out suction when tank is full
- Quick connection/release hinges for filter and tank cleaning
- Kink-resistant suction hose
- Pivoting wheels
- Built-in accessory holder



MOD	COD							
		K <sup>PA</sup>	l/s	STADI STAGES	W(MAX)	W	Hz	V
4200	50181	23,5	59,7	2	1400	1200	50	230~

dB(A)	l	kg
60	36	13,7

### Accessori standard Standard accessories





# 42 Series 4200P

ASPIRATORI SOLIDI LIQUIDI  
wet & dry vacuum cleaners

## OLIGHTPRO



Cerniere aggancio/sgancio rapido per pulizia filtri e fusto  
Quick connection/release hinges for filter and tank cleaning



Fusto raccolta in materiale plastico robusto e resistente  
Tough, sturdy plastic tank



4 ruote pivotanti e stabili  
4 stable castor wheels



### Caratteristiche Generali

- Serie professionale compatta dedicata all'aspirazione di polveri e liquidi
- Fusto in polipropilene
- Motore bi-stadio
- Ideale per la pulizia in spazi ridotti

### General Features

- Professional dust and liquid vacuum cleaner series
- Polypropylene body
- Two-stage motor
- Ideal for cleaning in tight spaces

1400 W

36 lt

Ø 40

MOD	COD							
		K <sup>PA</sup>	l/s	STADI STAGES	W(MAX)	W	Hz	V
4200P	51061	23,5	59,7	2	1400	1200	50	230~

dB(A)	l	kg
60	36	12,6

### Accessori standard Standard accessories





### HEAVYPRO



**NEW**

#### Caratteristiche Generali

- Modello professionale compatto dedicato all'aspirazione di polveri e liquidi
- Fusto in polipropilene
- Motore ad alta efficienza
- Galleggiante per interrompere l'aspirazione quando il fusto è pieno
- Cerniere aggancio/sgancio rapido per pulizia filtri e fusto
- Tubo d'aspirazione resistente alla torsione
- Ruote pivotanti antitraccia
- Porta accessori integrato
- Funzione drenante
- Tubo flessibile per scarico liquidi

#### General Features

- Professional dust and liquid vacuum cleaner
- Polypropylene body
- High efficiency motors
- Float switch to cut out suction when tank is full
- Quick connection/release hinges for filter and tank cleaning
- Kink-resistant suction hose
- No markings pivoting wheels
- Built-in accessory holder
- Drain systems
- Flexible hose for liquid discharges

4300MP	4400MP
<b>2400 W</b>	<b>3300 W</b>
	<b>77 lt</b>
	<b>Ø 40</b>

MOD	COD									
		K <sup>PA</sup>	I/s	N°	STADI STAGES	W(MAX)	W	Hz	V	
4300MP	52507	20,5	94,5	2	1	2400	2050	50	230~	
4400MP	52508	20,5	141,7	3	1	3300	2900	50	230~	

#### Accessori standard Standard accessories



dB(A)	l	kg
67	77	22
68	77	27





# 43.44 Series 4300P.4400P

ASPIRATORI SOLIDI LIQUIDI  
wet & dry vacuum cleaners

## HEAVYPRO



### Caratteristiche Generali

- Modello professionale compatto dedicato all'aspirazione di polveri e liquidi
- Fusto in polipropilene
- Motore bi-stadio
- Galleggiante per interrompere l'aspirazione quando il fusto è pieno
- Cerniere aggancio/sgancio rapido per pulizia filtri e fusto
- Tubo d'aspirazione resistente alla torsione
- Ruote pivotanti
- Porta accessori integrato

### General Features

- Professional dust and liquid vacuum cleaner
- Polypropylene body
- Two-stage motor
- Float switch to cut out suction when tank is full
- Quick connection/release hinges for filter and tank cleaning
- Kink-resistant suction hose
- Pivoting wheels
- Built-in accessory holder

4300P      4400P

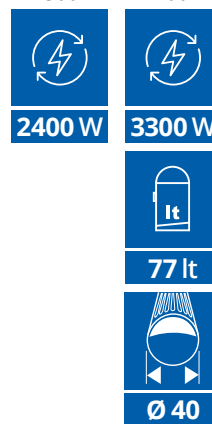

MOD	COD									
		K <sup>PA</sup>	l/s	N <sup>o</sup>	STADI STAGES	W(Max)	W	Hz	V	
4300P	52509	22,1	94,5	2	2	2400	2050	50	230~	
4400P	52510	22,1	141,7	3	2	3300	2900	50	230~	

### Accessori standard Standard accessories



dB(A)	l	kg
67	77	22
68	77	27

### HEAVYPRO



fusto basculante  
body which tilts for  
emptying

fusto raccolta in acciaio inox  
stainless steel tank

2 ruote posteriori con  
battistrada in gomma  
2 rubber rear wheels

2 ruote pivotanti e stabili  
2 stable castor wheels



### Caratteristiche Generali

- Modello professionale compatto dedicato all'aspirazione di polveri e liquidi
- Fusto in acciaio inox
- Motori bi-stadio
- Galleggiante per interrompere l'aspirazione quando il fusto è pieno
- Cerniere aggancio/sgancio rapido per pulizia filtri e fusto
- Tubo d'aspirazione resistente alla torsione
- Ruote pivotanti antitraccia
- Porta accessori integrato

### General Features

- Professional dust and liquid vacuum cleaner
- Stainless steel body
- Two-stage motors
- Float switch to cut out suction when tank is full
- Quick connection/release hinges for filter and tank cleaning
- Kink-resistant suction hose
- No markings pivoting wheels
- Built-in accessory holder

MOD	COD									
		K <sup>PA</sup>	l/s	N°	STADI STAGES	W(Max)	W	Hz	V	
4300	52511	22,1	94,5	2	2	2400	2050	50	230~	



dB(A)	l	kg
67	77	24

### Accessori standard Standard accessories





# 44 Series 4400

ASPIRATORI SOLIDI LIQUIDI  
wet & dry vacuum cleaners

## HEAVYPRO



fusto basculante  
body which tilts for  
emptying



fusto raccolta in acciaio inox  
stainless steel tank



2 ruote posteriori con  
battistrada in gomma  
2 rubber rear wheels



2 ruote pivotanti e stabili  
2 stable castor wheels



### Caratteristiche Generali

- Modello professionale compatto dedicato all'aspirazione di polveri e liquidi
- Fusto in acciaio inox
- Motori bi-stadio
- Galleggiante per interrompere l'aspirazione quando il fusto è pieno
- Cerniere aggancio/sgancio rapido per pulizia filtri e fusto
- Tubo d'aspirazione resistente alla torsione
- Ruote pivotanti antitraccia
- Porta accessori integrato

### General Features

- Professional dust and liquid vacuum cleaner
- Stainless steel body
- Two-stage motors
- Float switch to cut out suction when tank is full
- Quick connection/release hinges for filter and tank cleaning
- Kink-resistant suction hose
- No markings pivoting wheels
- Built-in accessory holder

3300 W

77 lt

Ø 40

MOD	COD								
		K <sup>PA</sup>	l/s	N°	STADI STAGES	W(MAX)	W	Hz	V
4400	52512	22,1	141,7	3	2	3300	2900	50	230~



dB(A)	l	kg
68	77	29

### Accessori standard Standard accessories



## HEAVYPRO



### Caratteristiche Generali

- Modello professionale compatto dedicato all'aspirazione di polveri e liquidi
- Fusto in acciaio inox
- Motori bi-stadio
- Ideale per la pulizia in spazi ridotti
- Galleggiante per interrompere l'aspirazione quando il fusto è pieno
- Cerniere aggancio/sgancio rapido per pulizia filtri e fusto
- Tubo d'aspirazione resistente alla torsione
- Ruote pivotanti
- Porta accessori integrato
- Presa elettrica per elettroutensile

### General Features

- Professional dust and liquid vacuum cleaner
- Stainless steel body
- Two-stage motors
- Ideal for cleaning in tight spaces
- Float switch to cut out suction when tank is full
- Quick connection/release hinges for filter and tank cleaning
- Kink-resistant suction hose
- Pivoting wheels
- Built-in accessory holder
- Electric socket for power tool



MOD	COD							
4700S <sup>°</sup>	51065	23,5	59,7	2	1400	1200	50	230~

<sup>°</sup> Potenza massima utensile 1400 W  
Tool max power 1,400 W

60	36	14

### Accessori standard

Standard accessories





# 48 Series 4800

ASPIRAPOLVERI  
vacuum cleaners

## HEAVYPRO



### Caratteristiche Generali

- Modello professionale dedicato all'aspirazione di sole polveri
- Fusto in acciaio inox
- Motore bi-stadio
- Con presa elettrica per elettroutensile e dispositivo scuotifiltro automatico
- Filtro ad alta efficienza

### General Features

- Professional vacuum cleaner for dry materials only
- Stainless steel body
- Two-stage motor
- With power tool socket and automatic filter shaker device
- High efficiency filter



MOD	COD								
		K <sup>PA</sup>	l/s	STADI STAGES	W(MAX)	W	Hz	V	
4800 <sup>°</sup>	51203	23,5	59,7	2	1400	1200	50	230~	

<sup>°</sup> Potenza massima utensile 1400 W  
Tool max power 1,400 W

dB(A)	l	kg
60	37	13,9

### Accessori standard Standard accessories

50212 (3,3 m)      51073 (Ø202)

Kit 51108 NOT INCLUDED



## HEAVYPRO



### Caratteristiche Generali

- Modello professionale dedicato alla pulizia di tappeti, poltrone e pavimenti
- Motore bi-stadio
- Serbatoio detergente incorporato (capacità 8l)
- Fusto in plastica
- L'utilizzo è sempre associato alla contemporanea erogazione ed aspirazione di detergente (acqua o miscela di acqua e detergente idoneo da effettuare prima di immettere nel serbatoio con portata di 0,8 l/min a 2 bar di pressione)

### General Features

- Professional vacuum cleaner for cleaning carpets, upholstery and floors
- Two-stage motor
- Built-in detergent tank (capacity 8 l)
- Plastic body
- When in operation, it simultaneously delivers and sucks in detergent (water or a mixture of water and a suitable detergent, to be prepared before transfer to the tank) with a flow rate of 0.8 l/min at a pressure of 2 bar.



MOD	COD				
		K <sup>P</sup> A	l/s	STADI STAGES	W(MAx)
4200L	51289	23,5	59,7	2	1400

l/min	bar	W	l
0,8	2	48	8

dB(A)	l	kg
60	36	14

### Accessori standard Standard accessories





# 43L Series 4300L

ASPIRATORI SOLIDI LIQUIDI  
wet & dry vacuum cleaners

## HEAVYPRO



fusto basculante  
body which tilts for  
emptying



serbatoio detergente  
incorporato (20l)  
built-in detergent tank (20 l)

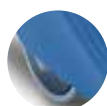

2 ruote posteriori con  
battistrada in gomma  
2 rubber rear wheels



presa detergente  
detergent socket



fusto raccolta in acciaio inox  
stainless steel tank

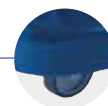

2 ruote pivotanti e stabili  
2 stable castor wheels



### Caratteristiche Generali

- Modello professionale dedicato alla pulizia di tappeti, poltrone e pavimenti
- Motori bi-stadio
- Serbatoio detergente incorporato (capacità 20l)
- Fusto basculante in acciaio inox
- L'utilizzo è sempre associato alla contemporanea erogazione ed aspirazione di detergente (acqua o miscela di acqua e detergente idoneo da effettuare prima di immettere nel serbatoio con portata di 0,8 l/min a 2

### General Features

- Professional vacuum cleaner for cleaning carpets, upholstery and floors
- Two-stage motors
- Built-in detergent tank (capacity 20 l)
- Tilting stainless steel body
- When in operation, it simultaneously delivers and sucks in detergent (water or a mixture of water and a suitable detergent, to be prepared before transfer to the tank) with a flow rate of 0.8 l/min at a pressure of 2 bar.



MOD	COD								
		K <sup>P</sup> A	l/s	N°	STADI STAGES	W(MAX)	W	Hz	V
4300L	51205	23,5	94,5	2	2	2400	2300	50	230~

CHEM	CHEM	kw	CHEM
l/min	bar	W	l
0,8	2	48	20

dB(A)	l	kg
67	76	27,5

### Accessori standard Standard accessories



51215 (2,5 m)



51216



51070



## HEAVYPRO



fusto basculante  
body which tilts for  
emptying



fusto raccolta in acciaio inox  
stainless steel tank



2 ruote posteriori con  
battistrada in gomma  
2 rubber rear wheels



2 ruote pivotanti e stabili  
2 stable castor wheels



### Caratteristiche Generali

- Modello professionale dedicato all'aspirazione di trucioli da lavorazioni metalliche industriali
- Filtro di aspirazione ad elevata superficie filtrante e protezione a barriera
- Fusto in acciaio inox
- Motori bi-stadio
- Carrello, maniglia e fusto basculante per svuotamento
- Filtro ad alta efficienza

### General Features

- Model specifically designed for collection of shavings from industrial metalworking processes
- Suction filter with large filtering surface area and barrier protection
- Stainless steel body
- Two-stage motors
- Trolley, handle and tilting body for emptying
- High efficiency filter

<b>3600 W</b>	<b>77 lt</b>
<b>Ø 50</b>	

MOD	COD								
		K <sup>PA</sup>	l/s	N°	STADI STAGES	W(MAX)	W	Hz	V
4900	51067	23,5	179,2	3	2	3600	3150	50	230~



<b>dB(A)</b>	<b>l</b>	<b>kg</b>
68	77	29,8

### Accessori standard Standard accessories



Kit 52362  
NOT INCLUDED  
BUY WITH Kit  
51108



**ACCESSORI**

*Accessories*







## ACCESSORI SPECIALI

*SPECIAL ACCESSORIES*

### ACCESSORIO 3 IN 1

#### *SIDEKICK PRO*

Cod. 46267

L'accessorio 3 in 1 ARBC è un aiuto nei lavori di bricolage domestici. Ha una tripla funzione: sorregge piccole mensole o listelli; permette di regolarne l'altezza grazie al supporto rotante a 360°; raccoglie la polvere di fori da trapano su pareti e soffitti.

*AR Blue Clean Sidekick Pro accessory is a helpful tool in domestic and DIY works. It has a triple function: supports small shelves or strips; allows you to adjust the height thanks to the 360° rotating support; collects dust from drill holes on walls and ceilings.*





## RACCOGLIPOLVERE DA FORATURA

**DRILLDUST COLLECTOR**

Cod. 46266

L'accessorio raccogli-polvere da foratura per aspiratori solidi e liquidi ARBC permette di raccogliere la polvere generata dall'utilizzo di trapani e avvitatori.

*DrillDust Collector accessory for AR Blue Clean solid and liquid vacuum cleaners allows to collect the dust from drills and screwdrivers.*

## VENTOSA STURATUBI

**DRAIN UNBLOCKER**

Cod. 46265

L'accessorio ventosa sturatubi per aspiratori solidi e liquidi ARBC consente di liberare e ripulire gli scarichi intasati. Grazie alla potenza dell'aspirazione garantisce una pulizia profonda senza residui. L'innovativo design permette l'aderenza a tutte le tipologie di scarichi.

*The Drain Unblocker accessory for AR Blue Clean solid and liquid vacuum cleaners allows you to free and clean up clogged drains. Thanks to the suction power guarantees a deep cleaning without residues. The innovative design allows adherence to all kind of drains.*





















# Vacuum cleaners Series

ACCESSORI  
accessories

			31 Series	32 Series	33 Series	36 Series	37 Series		ASH cleaners	41 Series	42 Series	43 Series	44 Series	43 Series	44 Series	43 Series	44 Series	48 Series	42 Series	43 Series	49 Series			
			3170	3270	3370	3670	3770	3780	E12 M20	4100	4200	4200P	4300MP	4400MP	4300P	4400P	4300	4400	4700S	4800	4200L	4300L	4900	
Spazzola per pavimenti secco/umido <i>Floor wet&amp;dry brush</i>		4340150 (ø35)	S	S	S	S	S		S															
Spazzola per pavimenti per umido <i>Brush for wet floor</i>		4341430 (ø35)	O	O	O	O	O		O															
		4341330 (ø40)						S																
Spazzola combinata in plastica per pavimenti <i>Combined plastic floor brush</i>		4341340 (ø35) solo secco <i>dry only</i>	O	O	O	O	O		O															
Spazzola combinata con inserto metallico per pavimenti <i>Combined metal floor brush</i>		4340750 (ø35) solo secco <i>dry only</i>	O	O	O	O	O		O															
		4341370 (ø40) solo secco <i>dry only</i>						O																
Spazzola per pavimenti combinata solo secco <i>Combined floor brush dry only</i>		46254 (ø35)	O	O	O	O	O	O	O															
Spazzola per pulizia tappeti e poltrone <i>Carpet and upholstery brush</i>		4340180 (ø35)	O	O	O	O	O		S															
Spazzola rotonda <i>Round brush</i>		46255 (ø35)	O	O	O	O	O		O															
		4341360 (ø40)						O																
Bocchetta per superfici secco/umido <i>Wet&amp;dry nozzle</i>		4340740 (ø40)						O																
Bocchetta per fessure <i>Crevice nozzle</i>		4340170 (ø35)	S	S	S	S	O		S															
Bocchetta grande per fessure <i>Wide crevice nozzle</i>		4340730 (ø35)	O	O	O	O	S																	
Bocchetta per fessure <i>Crevice nozzle</i>		4341350 (ø40)						S																
Ventosa sturatubi <i>Suction cup drain unblocker</i>		46265	O	O	O	O	O	O	O															
Raccogli polvere da foratura <i>Drilldust collector</i>		46266	O	O	O	O	O	O	O															
Accessorio 3in1 <i>Sidekick Pro 3in1</i>		46267	O	O	O	O	O	O	O															

**Legenda: "S" Accessorio di serie - "O" Accessorio opzionale**  
"S" On board accessory - "O" Optional accessory

		31 Series	32 Series	33 Series	36 Series	37 Series	ASH cleaners	41 Series	42 Series	43 Series	44 Series	43 Series	44 Series	43 Series	44 Series	47 Series	48 Series	42 Series	43 Series	49 Series			
		3170	3270	3370	3670	3770	3780	E12 M20	4100	4200	4200P	4300MP	4400MP	4300P	4400P	4300	4400	4700S	4800	4200L	4300L	4900	
Adattatore per elettrooutensili <i>Adapter for power tools</i>		46264				S	S																
Tubo di aspirazione con gomito <i>Suction hose with elbow</i>		4341870 (ø35/1,5 m)	S	S																			
		4341310 (ø35/2 m)	O	O	S	S	S		S														
		4341780 (ø35/5 m)	O	O	O	O	O																
		4341800 (ø35/10 m)	O	O	O	O	O																
Tubo rigido di aspirazione in plastica <i>Plastic suction tube</i>		4341320 (ø40/2 m)					S																
		4341790 (ø40/5 m)						O															
		4341810 (ø40/10 m)						O															
		4340200 (ø35/3x330 mm)	S	S	S				S														
Tubi rigidi di aspirazione in metallo <i>Metal suction tubes</i>		4340210 (ø35/2x470 mm)				S	S																
		4341880 (ø40/2x480 mm)						S															
		4340230 (ø35/2x470 mm)	O	O	O	O	O		O														
Tubo telescopico in acciaio inossidabile <i>Stainless steel telescopic tube</i>		4341380 (ø40/2x480 mm) con gancio rimessaggio w/storage hook					O																
		4340240 (ø35/480-780mm)	O	O	O	O	O		O														
Sacchetto filtro carta <i>Paper filter bag</i> 5 pcs		46256 (15 l)	O																				
		46257 (20 l)		O	S				O														
		46258 (30 l)				S																	
		46270 (35 l)					S																
		46271 (50 l)						S															
Filtro stoffa lavabile <i>Washable fabric filter bag</i> 2 pcs		46259 (15 l)	S																				
		46260 (20 l)		S	O				O														
		46261 (30 l)				O																	
		46313 (35 l)					O																
	46314 (50 l)						O																

**Legenda: "S" Accessorio di serie - "O" Accessorio opzionale**  
"S" On board accessory - "O" Optional accessory



# Vacuum cleaners Series

ACCESSORI  
accessories

			31 Series	32 Series	33 Series	36 Series	37 Series	ASH cleaners	41 Series	42 Series	43 Series	44 Series	43 Series	44 Series	43 Series	44 Series	47 Series	48 Series	42 Series	43 Series	49 Series					
			3170	3270	3370	3670	3770	3780	E12 M20	4100	4200	4200P	4300MP	4400MP	4300P	4400P	4300	4400	4700S	4800	4200L	4300L	4900			
Filtro in spugna Sponge filter 5 pcs		46315	S																							
		46262		S	O	O	O	O																		
		47126								S																
Filtro cartuccia ad alta efficienza High efficiency cartridge		46269 (h= 91 mm)	O																							
		46263 (h= 115 mm)		O	S	S	S	S																		
Tubo aspirazione flessibile in metallo Flexible metal hose		5060130 (ø35 mm/1 m)							S																	
		4341700 (ø40 mm/1,2 m)								S																
Tubo in alluminio Aluminum suction tube		5060070 (ø34 mm/23 cm)							S																	
		4341710 (ø34 mm/23 cm)								S																
Prefiltro in tessuto ritardante Fire retardant prefilter		43575							O	O																
Filtro cartuccia Cartridge filter		47127 (h= 115 mm)							S																	
Filtro alta efficienza plissettato con protezione metallica High efficiency pleated filter with metal garde		5060120 (h= 115 mm)							S																	
Spazzola pavimenti combinata in acciaio Steel combined brush		50200 (ø36)								S																
Spazzola completa liquidi Floor brush (only wet)		50201 (ø36)								S																
		50208 (ø37)									S	S														
		50210 (ø37/L 400 mm)												O	O	O	O	O	O							
Spazzola pavimenti Floor brush		50207 (ø37)								S	S															
		50209 (ø37)												O	O	O	O	O	O							
Corpo spazzola Nozzle body		52517 (ø40)											S	S	S	S	S	S								
Inserto spazzola pavimenti per secco Dry floor brush insert		51090											S	S	S	S	S	S								
Inserto spazzola pavimenti per umido Wet floor brush insert		51091											S	S	S	S	S	S								

Legenda: "S" Accessorio di serie - "O" Accessorio opzionale  
"S" On board accessory - "O" Optional accessory



			31 Series	32 Series	33 Series	36 Series	37 Series	3780	E12	M20	ASH cleaners	41 Series	42 Series	43 Series	44 Series	43 Series	44 Series	43 Series	44 Series	47 Series	48 Series	42 Series	43 Series	49 Series	
			3170	3270	3370	3670	3770					4100	4200	4200P	4300MP	4400MP	4300P	4400P	4300	4400	4700S	4800	4200L	4300L	4900
Bocchetta Small tool		50195 (ø36)										S													
Spazzola rotonda Round brush		50199 (ø36)										S													
		50204 (ø40)											S	S	S	S	S	S	S	S					
Lancia piatta Crevice nozzle		50203 (ø40)										S	S	S	S	S	S	S	S						
Tubo flessibile completo Complete hose		50194 (ø36/2 m)										S													
		50202 (ø40/2,5 m)											S	S	S	S	S	S	S	S					
Tubo in metratura Hose supplied by the metre		51115 (ø40/15 m)											O	O	O	O	O	O	O	O	O	O			
		51391 (ø40/30 m)											O	O	O	O	O	O	O	O	O	O			
Tubo flessibile + tubo idrolitico Flexible hose + hydrolytic hose		51215 (ø40/2,5 m)																					S	S	
Tubo flessibile + manicotti elettrotensile Flexible hose with tool fitting collars		50212 (ø28/3,3 m)																			S	S			
Tubo PU antistatico Antistatic PU hose		51074 (ø50 / 2,5 m)																							S
Tronco conico antistatico Tapered antistatic attachment		51077 (ø50)																							S
Ventosa ondulata antistatica Corrugated antistatic sucker		51076 (ø50)																							S
Corpo spazzola polveri Carpet brush body		51216 (ø36)																					S	S	
Tubo prolunga plastica Plastic suction tube		51160 (ø36)										O	O												
		51207 (ø40)												O	O	O	O	O	O	O	O	O	O	O	O
Tubo acciaio dritto Chrome straight extension		50197 (ø36)										S													
		50206 (ø36)											S	S	S	S	S	S	S	S					
Tubo acciaio curvo Chrome curved extension wand		50205 (ø40)										S	S	S	S	S	S	S	S						

**Legenda: "S" Accessorio di serie - "O" Accessorio opzionale**  
"S" On board accessory - "O" Optional accessory



# Vacuum cleaners Series

ACCESSORI  
accessories

		31 Series	32 Series	33 Series	36 Series	37 Series	ASH cleaners	41 Series	42 Series	43 Series	44 Series	43 Series	44 Series	43 Series	44 Series	47 Series	48 Series	42 Series	43 Series	49 Series					
		3170	3270	3370	3670	3770	3780	E12	M20	4100	4200	4200P	4300MP	4400MP	4300P	4400P	4300	4400	4700S	4800	4200L	4300L	4900		
Tubo acciaio curvo maschio <i>Chrome curved extension wand male</i>		51131																						O	
Lancia conica antistatica <i>Tapered antistatic lance</i>		51075 (ø50)																							S
Lancia zincata <i>Galvanised lance</i>		51078 (ø50)																							S
Kit set accessori <i>Complete accessories kit</i>		51108																		O	O				O
Manicotto zincato giunto accessori <i>Galvanised accessories fitting collar</i>		51079 (ø50)																							S
Kit terminali per tubo in metratura <i>End piece kit for hose supplied by metre</i>		51177 (ø36)								O															
		51300 (ø28)																							
		51176 (ø40)									O	O	O	O	O	O	O	O	O	O	O				
Manicotto per prolunga tubo flessibile <i>Connector for hose supplied by meter</i>		51206 (ø36)								O															
		51319 (ø40)									O														
		51166 (ø40)																							O
Lancia lavapavimenti <i>Floor cleaning lance</i>		51217																							O
Dispositivo anti schiuma <i>Anti foam device</i>		50277									O	O	O	O	O	O	O	O	O						
Ciclone <i>Cyclon</i>		51081 (ø300)																							S
Aspiraliquidi <i>Liquid vacuum</i>		51474													O	O	O	O							O
Wet & Dry		(A) 51131 + (B) 51134																							O
Kit cestello separatore oli/ trucioli metallici <i>Oil/metal shaving basket filter kit</i>		51148																							O
Filtro sacchetto carta <i>Paper filter</i>		50231 (20 l) 10 pcs								O															
		51068 (36 l) 10 pcs									O	O													
		51082 (77 l) 5 pcs											O	O	O	O	O	O							

**Legenda: "S" Accessorio di serie - "O" Accessorio opzionale**  
"S" On board accessory - "O" Optional accessory

			31 Series	32 Series	33 Series	36 Series	37 Series	ASH cleaners	41 Series	42 Series	43 Series	44 Series	43 Series	44 Series	43 Series	44 Series	47 Series	48 Series	42 Series	43 Series	49 Series			
			3170	3270	3370	3670	3770	3780	E12	M20	4100	4200	4200P	4300MP	4400MP	4300P	4400P	4300	4400	4700S	4800	4200L	4300L	4900
Filtro in poliestere <i>Polyester filter</i>		51150 (20 l) 10 pcs									O													
		51084 (36 l) 5 pcs										O	O								O			
		51071 (77 l) 5 pcs														O		O						
Filtro in nylon <i>Nylon filter</i>		50211 (ø34)									O	O	O							O				
		51072 (ø44)												O	O	O	O	O	O					
Filtro in poliestere <i>Polyester filter</i>		50413 (ø340)										S	S							S	O			
		50368 (ø440)												S	S	S	S	S	S					
		51161 (ø340)									S													
Filtro spugna per liquidi <i>Sponge filter for wet uses</i>		51083 (ø440)																						O
		51070									S	S	S	S	S	S	S	S	S	S	S	S	S	S
Filtro cartuccia conico <i>Conical cartridge filter</i>		51073 (ø202)																		S				
Filtro cartuccia <i>Cartridge filter</i>		50230 (ø175)									O	O	O							O				
		50233 (ø250)												O	O	O	O	O	O					
		51080 (ø250 polyester)																						S

**Legenda: "S" Accessorio di serie - "O" Accessorio opzionale**  
"S" On board accessory - "O" Optional accessory

# WATER PUMPS

Le pompe Annovi Reverberi sono la soluzione perfetta per liberare dall'acqua ambienti come piscine, vasche, laghetti, oppure per l'irrigazione di piante e vegetazione. Sono inoltre in grado di rimuovere l'acqua in eccesso causata da allagamenti di tipo domestico o naturale. Grazie alla funzione dell'autoclave possono integrarsi con l'approvvigionamento idrico domestico per riutilizzare l'acqua piovana o proveniente da fonti alternative per scarichi o lavatrici, evitando così l'eventuale spreco di acqua potabile.

*The Annovi Reverberi pumps are the perfect solution to free water from environments such as swimming pools, ponds, or for watering plants and vegetation. They are also able to remove excess water caused by domestic or natural flooding.*

*Thanks to the autoclave function, they can be integrated with domestic water supply to reuse rainwater or water coming from alternative sources for drains or washing machines, thus avoiding any waste of drinking water.*







# Applicazioni

## Applications



**irrigazione manuale**  
manual irrigation



**irrigazione automatica**  
automatic irrigation



**acque per i servizi**  
water supply



**allagamenti domestici**  
house flooded



**pozzetti**  
wells



**piscine**  
swimming pools



**cantieri**  
construction site



**stagni/laghetti**  
ponds



**allagamenti**  
floodings

# Caratteristiche

## Features



**pressione massima**  
max pressure



**portata massima**  
max flow



**dimensioni di montaggio**  
fitting dimensions



**ON/OFF automatico**  
automatic ON/OFF



**sistema di scarico**  
drain system



**facile riempimento**  
easy fill



**impugnatura ergonomica**  
handle

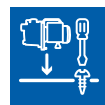

**montaggio da tavolo**  
table mounting



**serbatoio**  
tank



**ON/OFF automatico**  
automatic ON/OFF



**acqua residua**  
residual water



**dimensione massima particolato**  
max grain size



**altezza variabile**  
variable height



**corpo in acciaio inossidabile**  
stainless steel body



**testata pompa in acciaio inossidabile**  
stainless steel pump head



**adatto ad acque pulite**  
suitable for clean water



**adatto ad acque sporche**  
suitable for dirty water



### Autoadescanti Self-priming

600P



800X



1100X



### Con autoclave With booster unit

600PB



800XB



1100XB



### Immersione Submersible

250PC



400PC



750XC



750PT



1100XD



# POMPE AUTOADESCANTI *SELF-PRIMING* *PUMPS*

Le pompe autoadescenti della gamma Annovi Reverberi forniscono la condizione ideale per una crescita rigogliosa delle piante e garantisce una conveniente fornitura di acqua di servizio per la casa e il giardino.

Consentono il recupero dell'acqua attingendo da fonti alternative come pozzi o bacini, per sistemi di irrigazione fissi o mobili, oppure per riempire piscinette o fontane.

Grazie al sistema di risparmio energetico ON/OFF, le pompe offrono una soluzione sostenibile e rispettosa dell'ambiente.

*Annovi Reverberi's self-priming jet pumps range provides the ideal condition for the lush growth of the garden plants and grants a convenient service water supply for home and garden.*

*It allows water recycling especially useful for fixed or mobile irrigation systems or to fill small pools or fountains, by drawing from alternative sources such as wells or basins.*

*Thanks to the energy saving ON / OFF system, the pumps offer a sustainable and environment friendly solution.*





# ARGP Series 600P

POMPE AUTOADESCANTI  
self-priming pumps

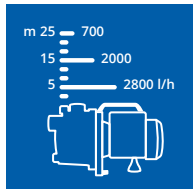

sistema di  
riempimento  
filling system

impugnatura ergonomica  
hand grip handle

sistema di  
svuotamento rapido  
quick emptying system



## Caratteristiche Generali

- La portata max. da 3100 l/h offre alte prestazioni
- Basso consumo energetico
- Autoadescante
- Protezione motore dalle alte temperature

## General Features

- 3100 l/h max. flow rate offers high performance
- Low power consumption
- Self priming
- Motor protection at high temperatures



MOD	COD					
		V	Hz	W	m	l/h
600P	51986	230~	50	600	35	3100

T(Max)	IP X	kg NET
35°C	4	6,3

## Accessori opzionali Optional accessories



46489



46491  
(1L)



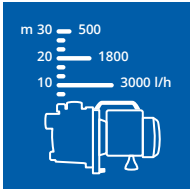

impugnatura ergonomica  
hand grip handle

testata in acciaio  
stainless steel head

## Caratteristiche Generali

- La portata max. da 3500 l/h offre alte prestazioni
- Autoadescante
- Protezione motore dalle alte temperature

## General Features

- 3500 l/h max. flow rate offers high performance
- Self-priming
- Motor protection at high temperatures



MOD	COD					
		V	Hz	W	m	l/h
800X	51988	230~	50	800	38	3500

T(Max)	IP X	kg NET
35°C	4	6,5

## Accessori opzionali Optional accessories



46489



46491  
(1L)



# ARGP Series 1100X

POMPE AUTOADESCANTI  
self-priming pumps

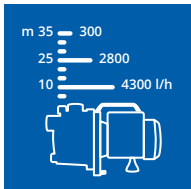

testata in acciaio  
stainless steel head

impugnatura ergonomica  
hand grip handle

## Caratteristiche Generali

- La portata max. da 4600 l/h offre alte prestazioni
- Motore performante
- Protezione motore dalle alte temperature

## General Features

- 4600 l/h max. flow rate offers high performance
- Powerful motor
- Motor protection at high temperatures



MOD	COD					
		V	Hz	W	m	l/h
1100X	51990	230~	50	1100	45	4600

T(Max)	IP X	kg NET
35°C	4	9,1

## Accessori opzionali Optional accessories



46489



46491  
(1L)



# POMPE AUTOADESCANTI CON AUTOCLAVE *SELF-PRIMING PUMPS WITH BOOSTER UNIT*

Le pompe autoadescenti con autoclave della serie AR Blue Clean forniscono acqua da utilizzare con elettrodomestici, sanitari o per l'irrigazione del giardino, mantenendo una pressione stabile e costante.

Le pompe si integrano con l'approvvigionamento idrico domestico, per l'utilizzo dell'acqua piovana, di serbatoi o di pozzi, evitando lo spreco di acqua potabile.

Grazie al sistema di risparmio energetico ON/OFF, queste pompe offrono una soluzione sostenibile e rispettosa dell'ambiente.

*The self-priming pumps with pressure tank, provided by Annovi Reverberi, excel at supplying water for domestic clean water fixtures or for garden irrigation, maintaining a stable and constant pressure.*

*The pumps can be integrated with domestic water supply systems, since their use of rainwater, drawn from tanks or wells, prevents the waste of drinking water.*

*Thanks to the energy saving ON/OFF system, the pumps offer a sustainable and environment friendly solution.*









# ARGP Series 600PB

**POMPE AUTOADESCANTI  
CON AUTOCLAVE**  
self-priming pumps with booster unit



riempimento  
pompa facilitato  
 *pump easy fill*

impugnatura  
ergonomica  
 *hand grip handle*

ON/OFF automatico  
 *automatic ON/OFF*

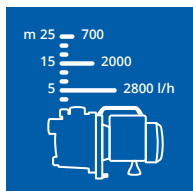
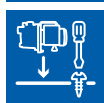

## Caratteristiche Generali

- La portata max. da 3100 l/h offre alte prestazioni
- Serbatoio 19L in acciaio
- Interruttore automatico ON/OFF
- Protezione motore dalle alte temperature

## General Features

- 3100 l/h max. flow rate offers high performance
- 19L steel pressure tank
- Automatic ON/OFF switch
- Motor protection at high temperatures



MOD	COD					
		V	Hz	W	m	l/h
600PB	51987	230~	50	600	35	3100

T(Max)	IP X	kg NET
35°C	4	10,8

## Accessori opzionali Optional accessories



46489



46492  
(2L)

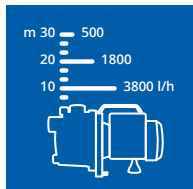
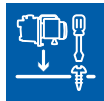

## Caratteristiche Generali

- La portata max. da 3500 l/h offre alte prestazioni
- Serbatoio 19L in acciaio
- Interruttore automatico ON/OFF
- Protezione motore dalle alte temperature

## General Features

- 3500 l/h max. flow rate offers high performance
- 19L steel pressure tank
- Automatic ON/OFF switch
- Motor protection at high temperatures

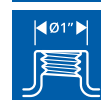

MOD	COD					
		V	Hz	W	m	l/h
800XB	51989	230~	50	800	38	3500

T(Max)	IP X	kg NET
35°C	4	10,9

## Accessori opzionali Optional accessories



46489



46492  
(2L)



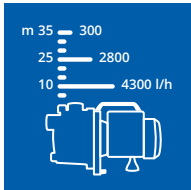
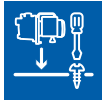

## Caratteristiche Generali

- La portata max. da 4600 l/h offre alte prestazioni
- Motore performante
- Serbatoio 24L in acciaio
- Interruttore automatico ON/OFF
- Protezione motore dalle alte temperature

## General Features

- 4600 l/h max. flow rate offers high performance
- Powerful motor
- 24L steel pressure tank
- Automatic ON/OFF switch
- Motor protection at high temperatures

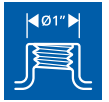

MOD	COD	V	Hz	W	m	l/h
1100XB	51991	230~	50	1100	45	4600

T(Max)	IP X	kg NET
35°C	4	14,1

## Accessori opzionali Optional accessories



46489



46492  
(2L)

# POMPE AD IMMERSIONE *SUBMERSIBLE PUMPS*

Elimina ogni residuo di acqua!  
Le pompe ad immersione della gamma AR Blue Clean spostano grandi quantità di acqua in poco tempo, fino a 16000 litri all'ora. Le pompe possono essere utilizzate per trasportare acqua pulita o sporca. Il design innovativo consente all'utente di rimuovere l'acqua lasciando solo 5mm di acqua residua sulla superficie piana. Il caratteristico interruttore a galleggiante consente di avviare automaticamente le pompe quando necessario.

*Get rid of any water residue!  
Annovi Reverberi submersible pumps move large volumes of water in a short time, up to 16000 liters per hour. They can be used to pump out clean or dirty water. The innovative design allows the user to remove the water leaving only 5mm of residual water on the flat surface. The characteristic float switch allows the pumps to be started automatically whenever necessary.*







G 1" 1/2 - 38 mm  
G 1" - 25 mm  
Ø 1" - 25 mm  
Ø 1" 1/4 - 32 mm

galleggiante con sistema di accensione/spegnimento float with ON/OFF system

acque pulite  
clean water

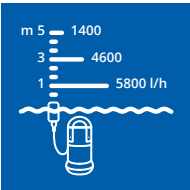

## Caratteristiche Generali

- Motore a basso consumo
- Interruttore a galleggiante integrato
- 5 mm min. di livello di aspirazione
- Protezione motore dalle alte temperature

## General Features

- Low consumption motor
- Integrated float switch
- 5mm minimum suction level
- Motor protection at high temperatures

250 PC



400PC



MOD	COD					
		V	Hz	W	m	l/h
250PC	51982	230~	50	250	6	6000
400PC	52172	230~	50	400	8	7000

T(Max)	IP X	kg NET
35°C	8	3,7
35°C	8	4,2

## Accessori opzionali Optional accessories



46490

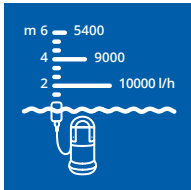

G 1"1/2 - 38 mm  
G 1" - 25 mm  
Ø 1" - 25 mm  
Ø 1" 1/4 - 32 mm

acque pulite  
clean water



galleggiante con sistema  
di accensione/spengimento  
float with ON/OFF system

## Caratteristiche Generali

- Design compatto
- Corpo in acciaio inox resistente alla corrosione
- Protezione motore dalle alte temperature

## General Features

- Compact design
- Corrosion-resistant stainless steel body
- Motor protection at high temperatures



MOD	COD	V	Hz	W	m	l/h
750XC	51984	230~	50	750	8,5	11000

T(Max)	IP X	kg NET
35°C	8	5

## Accessori opzionali Optional accessories



46490



# ARUP Series 750PT

POMPE AD IMMERSIONE  
submersible pumps

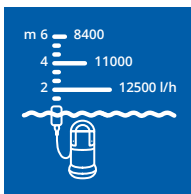

G 1" 1/2 - 38 mm  
 G 1" - 25 mm  
 Ø 1" - 25 mm  
 Ø 1" 1/4 - 32 mm

altezza variabile  
 per il passaggio  
 di acqua pulita/sporca  
*variable height for passage  
 of clean/dirty water*



galleggiante con sistema  
 di accensione/spengimento  
*float with ON/OFF system*

## Caratteristiche Generali

- Interruttore a galleggiante integrato
- Piedi pieghevoli per variare l'aspirazione da acque chiare a scure
- Protezione motore dalle alte temperature

## General Features

- *Integrated float switch*
- *Folding legs to swith from clean to dirty water suction*
- *Motor protection at high temperatures*



MOD	COD					
		V	Hz	W	m	l/h
750PT	51983	230~	50	750	8	13000

T(Max)	IP X	kg NET
35°C	8	5,24

## Accessori opzionali Optional accessories



46490

# Sistema multifunzione.

*Multifunction system.*



## MODALITÀ ACQUA SPORCA

Aperto i piedi della pompa si ha la possibilità di drenare acque molto sporche con residui di diametro fino a 30 mm.

### DIRTY WATER MODE

*Unfolding the pump feet you can drain very dirty water with residues up to 30mm in diameter.*

## MODALITÀ ACQUA PULITA

Con i piedi chiusi la pompa consente il drenaggio di acqua pulita lasciando un residuo di soli 5 mm.

### CLEAN WATER MODE

*Folding the pump feet allows you the drainage of clean water leaving a residue of only 5 mm.*





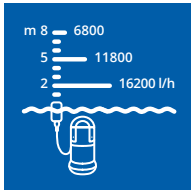

G 1" 1/2 - 38 mm  
G 1" - 25 mm  
Ø 1" - 25 mm  
Ø 1" 1/4 - 32 mm

acque sporche  
dirty water

galleggiante con sistema  
di accensione/spegnimento  
float with ON/OFF system



## Caratteristiche Generali

- Motore performante
- Corpo in acciaio inox resistente alla corrosione
- Protezione motore dalle alte temperature

## General Features

- Powerful motor
- Corrosion-resistant stainless steel body
- Motor protection at high temperatures







MOD	COD	V	Hz	W	m	l/h
1100XD	51985	230~	50	1100	10,5	16500

T(Max)	IP X	kg NET
35°C	8	6,6

## Accessori opzionali Optional accessories



46490

			Autoascanti <i>Self-priming</i>			Con autoclave <i>With booster unit</i>			Immersione <i>Submersible</i>				
			600P	800X	1100X	600PB	800XB	1100XB	250PC	400PC	750XC	750PT	1100XD
Tubo di aspirazione <i>Suction hose</i>		46489	<input type="radio"/>	<input type="radio"/>	<input type="radio"/>	<input type="radio"/>	<input type="radio"/>	<input type="radio"/>					
Tubo di mandata <i>Delivery hose</i>		46490							<input type="radio"/>	<input type="radio"/>	<input type="radio"/>	<input type="radio"/>	<input type="radio"/>
Prefiltro <i>Water filter</i>		46491 (1L)	<input type="radio"/>	<input type="radio"/>	<input type="radio"/>								
Prefiltro <i>Water filter</i>		46492 (2L)				<input type="radio"/>	<input type="radio"/>	<input type="radio"/>					







# MERCHAN- DISING







# AR Blue Display

MERCHANDISING  
merchandising



**A**

**ESPOSITORI  
EXHIBITORS**



**B**

**DETERGENT DISPLAY**



**C**

**BANDIERE  
FLAGS**



**D**

**TOTEM**

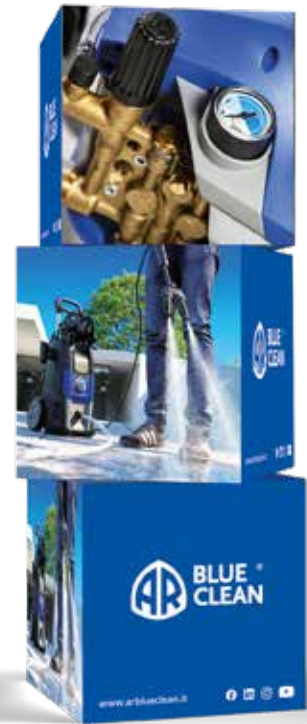

**E**

**CUBI  
CUBES**



**F**

**CORNER**



**G**

**CORNER DISPLAY**



**H**

**TESTER**

Adatti per allestire punti vendita, showroom ed insegne, i supporti in cartotecnica realizzati a marchio ARBC, hanno una buona resistenza all'usura e possono essere utilizzati sia per uso interno che esterno.

Lo spazio di un negozio non può essere neutrale, per questo i supporti alla vendita a marchio ARBC sono stati progettati in base alle necessità del punto vendita stesso, permettendo così di trovare il giusto punto di incontro fra l'offerta e la percezione che il cliente ne può avere.

Un punto vendita accogliente ed invitante infatti è fondamentale per mettere a proprio agio i clienti e incentivarli all'acquisto, è per questo che Annovi Reverberi ha deciso di mettere in risalto i prodotti nei diversi punti vendita unendo estetica e funzionalità.

*Suitable for point of sale and showroom outfitting and for signs, ARBC brand cardboard sales tools are hard-wearing and can be used both indoors and outdoors.*

*A store space cannot be anonymous, and so ARBC sales tools are designed specifically for the point of sale's needs, establishing the right connection between the offering and the customer's perception of it.*

*An attractive, inviting point of sale is fundamental for putting customers at their ease and encouraging them to purchase, and so Annovi Reverberi has chosen this stylish yet very practical means of highlighting its products in the various points of sale.*

## Dati Tecnici / Technical Data

MOD	REF	COD	DIMENSIONS mm (LxWxH)	kg	N° PEZZI
AR Blue Display	A	900000026	530x541X2231	26	1
Detergent Display	B	900000027	440x305x1580	4,5	64
AR Flag	C	900000018	780x600x2380	2,0	1
AR Totem	D	900000220	430X200X1530	0,7	1
AR Cubes	E	900000218	420X420X420	0,9	1
AR Corner	F	900000162	400X300X1800	7,5	1
AR Corner Display	G	900000163	400X300X1800	8,5	1
AR Tester	H	900000164	400X330X750	9,0	1

AR BLUE CLEAN

2X 2 POWER UNITS, DOUBLE CLEANING

2X

SYSTEM

WPP

FAST





AR BLUE CLEAN



**2X** 2 POWER UNITS,  
DOUBLE  
CLEANING



[arblueclean.it](http://arblueclean.it)

AR BLUE CLEAN



[www.arblueclean.it](http://www.arblueclean.it)





# LOGISTIC DATA

*Dati logistici*





# Index

**DATI LOGISTICI**  
logistic data



Modello Model	AR code	EAN code	Dimensione scatola Box dimensions	Dimensioni esterne Outer dimensions	Q.ty pallet	Container		Camion Full Truck	Peso Weight
						20 ft	40 ft		
			(L x W x H) mm	(L x W x H) mm	n°	n°	n°	n°	Kg
117	13689	8016287136891	260x235x470	220x235x460	60°	1050~	2145~	1980	6,2
143	13690	8016287136907	300x235x470	280x240x650	48°	903~	1818~	1452	7
387	15458	8016287154581	315x283x500	280x253x705	32°	646	1298	1056	9,0
397	15459	8016287154598	315x283x730	280x253x705	16°	420	840	528	11,1
2.0	14986	8016287149860	360x340x815	330x307x790	12°	288~	576~	396	13,1
3.0	14988	8016287149884	360x340x815	330x307x790	12°	288~	576~	396	13,4
2.A	15153	8016287151535	360x340x815	330x307x790	12°	288~	576~	396	13,8
4.0	14792	8016287147927	420x395x770	449x388x895	10°	210~	435~	330	16,7
5.0	14793	8016287147934	420x395x770	449x388x895	10°	210~	435~	330	17,3
4.1Wi-Touch	15180	8016287151801	420x395x770	449x388x895	10°	210~	435~	330	17,3
492	15594	8016287155946	590x375x568	420x360x930	12°	228~	468~	396	22,5
587	15595	8016287155953	590x375x568	420x360x930	12°	228~	468~	396	24,5
BC250 DSS	15389	8016287153898	355x285x122	906x78x287	96	1728	3840	2496	3,5
589	14989	8016287149891	420x395x770	449x388x895	10°	210~	435~	330	27,2
591	14990	8016287149907	420x395x770	449x388x895	10°	210~	435~	330	28
7.0	15343	8016287153430	420x395x770	449x388x895	10°	210~	435~	330	28,9
611	15167	8016287151672	507x267x330	428x269x258	24°	672~	1407~	792	22,7
613	13975	8016287139755	500x300x420	434x275x263	24°	264	576	792	20,3
614	13977	8016287139779	500x300x420	434x275x263	24°	264	576	792	23
613 K	13976	8016287139762	485x495x600	449x452x806	12	120	252	312	29,2
614 K	13978	8016287139786	485x495x600	449x452x806	12	120	252	312	31,7
670	14680	8016287146807	507x267x330	380x239x260	24°	672~	1407~	792	22
671	14697	8016287146975	507x267x330	380x239x260	24°	672~	1407~	792	25,8
680	15267	8016287152679	507x267x330	428x269x258	24°	672~	1407~	792	23,4
680 K	15268	8016287152686	485x495x600	449x452x905	12	66	150	312	27,5
630	15512	8016287155120	500x300x360	390x240x230	24°	264	576	792	29
630 K	15589	8016287155892	485x495x600	449x452x905	12	120	252	312	36
780	22341-V	8016287223416	800x400x580	390x380x900	9	99	225	297	41
787	22320-V	8016287223201	800x400x580	390x380x900	9	99	225	297	43
930	14261	8016287142618	705x540x720	800x480x980	4°	66	138	132	50
960	15479	8016287154796	705x540x720	800x480x980	4°	66	138	132	52
980	15480	8016287154802	705x540x720	800x480x980	4°	66	138	132	62
1003	24385-V	8016287243858	725x490x770	670x490x900	4°	60	120	132	40,6
1003 RLW	24389-V	8016287243896	725x490x770	670x540x900	4°	60	120	132	53
1005	15602	8016287156028	725x490x770	670x540x900	4°	60	120	132	51,9

~ Floor loaded / sfuso  
• Europallet

**20"**
**40"**

**KG**
**GROSS**

Modello Model	AR code	EAN code	Dimensione scatola Box dimensions	Dimensioni esterne Outer dimensions	Q.ty pallet	Container		Camion Full Truck	Peso Weight
			(L x W x H) mm	(L x W x H) mm		20 ft	40 ft		
1007	15477-V	8016287154772	725x490x770	670x490x900	4°	60	120	132	64
1007 RLW	15478-V	8016287154789	725x490x770	670x540x900	4°	60	120	132	67,7
1003 XE	15165	8016287151658	725x490x770	670x540x900	4°	60	120	132	49,7
1006XE	15475	8016287154758	725x490x770	670x540x900	4°	60	120	132	51
1007 XE	15476	8016287154765	725x490x770	670x540x900	4°	60	120	132	64,5
1009	15590	8016287155908	725x490x770	670x540x900	4°	60	120	132	68,9
1009RLW	15354-V	8016287153546	725x490x770	670x540x900	4°	60	120	132	72,6
1015	25283-V	8016287252836	600x860x630	580x1020x830	6	66	150	198	77
1018	24491-V	8016287244916	600x860x630	580x1020x830	6	66	150	198	88
1018H	25272-V	8016287252720	600x860x630	580x1020x830	6	66	150	198	88
1120	22374-V	8016287223744	730x1130x760	650x1250x900	2	22	50	66	118
1415	26213	8016287262132	520x440x520	460x460x480	12°	228~	456~	264	19,8
1425	26215	8016287262156	510x590x565	650x505x890	6°	168~	340~	198	29,6
1435	26406	8016287264068	520x690x565	771x458x926	6°	140~	296~	198	35,1
1440	26216	8016287262163	520x690x565	771x458x926	6°	140~	296~	198	35,8
1445	26407	8016287264075	520x690x565	771x458x926	6°	140~	296~	198	36,1
1445 XE	27856	8016287278560	520x690x565	771x458x926	6°	140~	296~	198	36,1
1447	26578	8016287265782	520x690x565	770x480x890	12°	140	292	198	39,1
1450	26217	8016287262170	520x690x565	771x458x926	6°	140~	296~	198	39,1
1460	26218	8016287262187	830x595x690	900x530x900	4°	75~	162~	132	56,8
1475	26325	8016287263252	830x595x640	900x530x900	6°	72~	153~	198	64,1
1475 XE	27857	8016287278577	830x595x640	900x530x900	6°	72~	153~	198	64,1
1480	26219	8016287262194	830x595x690	900x530x900	4°	75~	162~	132	64,9
1490	26408	8016287264082	830x595x690	900x530x900	4°	75~	162~	132	64
2591	15376-V	8016287153768	510x770x700	500x730x920	6°	99	207	198	47
3590	24425-V	8016287244251	510x770x700	500x730x920	6°	99	207	198	53
4590	24426-V	8016287244268	510x770x700	500x730x920	6°	99	207	198	54
5670	25671-V	8016287256711	570x780x850	540x800x750	4	44	100	132	88
5850	25672-V	8016287256728	570x780x850	540x800x750	4	44	100	132	94
5870	25673-V	8016287256735	570x780x850	540x800x750	4	44	100	132	94
6640	25275-V	8016287252751	740x1140x1100	1000x570x820	1	30	64	72	112
6670	25288-V	8016287252881	740x1140x1100	1000x570x820	1	30	64	72	115
6950	24103-V	8016287241038	740x1140x1100	980x590x920	1	30	64	72	138
6970	25276-V	8016287252768	740x1140x1100	980x590x920	1	30	64	72	138
7850	25277-V	8016287252775	740x1140x1100	980x590x920	1	30	64	72	138

~ Floor loaded / sfuso  
• Europallet



# Index

**DATI LOGISTICI**  
logistic data



20"

40"







KG  
GROSS

Modello Model	AR code	EAN code	Dimensione scatola Box dimensions	Dimensioni esterne Outer dimensions	Q.ty pallet n°	Container		Camion Full Truck n°	Peso Weight Kg
			(L x W x H) mm	(L x W x H) mm		20 ft n°	40 ft n°		
7870	25278-V	8016287252782	740x1140x1100	980x590x920	1	30	64	72	145
8840	22913-V	8016287229132	740x1140x1140	1100x700x1040	1	30	64	72	173
8860	22914-V	8016287259149	740x1140x1140	1100x700x1040	1	30	64	72	180
8880	22915-V	8016287229159	740x1140x1140	1100x700x1040	1	30	64	72	174
1310	24894-V	8016287248945	730x1130x760	1100x650x700	2	22	50	66	103
1320	25273-V	8016287252737	730x1130x760	1100x650x700	2	22	50	66	103
1325	25274-V	8016287252744	730x1130x760	1100x650x700	2	22	50	66	103
1380	25284-V	8016287252843	760x1160x1080	1180x730x960	1	30	60	68	174
3170	51922-V	8016287519229	380x355x405	346x339x385	30*	552~	1140~	990	6,4
3270	51923-V	8016287519236	380x355x533	346x339x509	18*	412~	856~	792	7,0
3370	51924-V	8016287519243	410x410x485	415x415x473	24*	431~	864~	792	8,1
3670	51927-V	8016287519274	410x410x575	415x415x554	18*	359~	720~	594	8,4
3770	51928-V	8016287519281	495x460x570	465x444x560	6*	239~	488~	198	11,7
3780	51929-V	8016287519298	625x575x645	538x683x852	6*	108~	228~	198	16,8
E12	52445	8016287524452	260x260x340	250x250x330	60*	1158	2432	1188	3,1
M20	52013	8016287520133	410x410x485	415x415x473	24*	339	688	792	8,9
4100	50180	8016287511803	415x415x580	400x400x900	18*	280	560	594	12
4200	50181	8016287511810	415x415x580	400x400x800	15*	168	336	495	13,7
4200 P	51061	8016287510615	415x415x580	415x415x875	15*	168	336	495	12,6
4300MP	52507	8016287525077	415x415x800	400x400x800	15*	168	336	495	24
4400MP	52508	8016287525084	415x415x800	400x400x800	15*	168	336	495	27,5
4300 P	52509	8016287525091	590x615x1060	600x600x1100	4*	54	120	133	22
4400 P	52510	8016287525107	590x615x1060	600x600x1100	4*	54	120	133	27
4300	52511	8016287525114	590x615x1060	600x600x1100	4*	54	120	133	24
4400	52512	8016287525121	590x615x1060	600x600x1100	4*	54	120	133	29
4700 S	51065	8016287510653	415x415x800	600x600x1100	15*	168	336	495	14
4800	51203	8016287512039	410x410x810	600x600x1100	15*	175	362	495	13,9
4200 L	51289	8016287512893	415x415x820	400x400x800	15*	168	336	495	14
4300 L	51205	8016287512053	590x615x1060	620x620x1000	4*	54	120	133	27,5
4900	51067	8016287510677	500x600x1060	590x550x1040	4*	84	176	133	29,8
600P	51986	8016287519861	370x225x260	340x210x210	72*	1100~	2260~	*	7,4
800X	51988	8016287519885	370x225x260	340x210x210	72*	1030~	2115~	*	7,8
1100X	51990	8016287519908	410x250x280	380x220x225	49*	1030~	2115~	*	10,4
600PB	51987	8016287519878	485x300x550	440x270x510	18*	350~	730~	*	11,8
800XB	51989	8016287519892	485x300x550	440x270x510	18*	350~	730~	*	12,2

~ Floor loaded / sfuso  
• Europallet





Modello Model	AR code	EAN code				20"	40"		
			Dimensione scatola Box dimensions	Dimensioni esterne Outer dimensions	Q.ty pallet	Container		Camion Full Truck	Peso Weight
			(L x W x H) mm	(L x W x H) mm	n°	20 ft	40 ft	n°	Kg
<b>1100XB</b>	51991	8016287519915	520x300x560	500x270x530	12*	335~	690~	*	15,4
<b>250PC</b> ◊	51982	8016287519823	220x160x330	165x158x305	100*	1864~	3436~	*	4,4
<b>400PC</b> ◊	52172	8016287521727	220x160x330	165x158x305	100*	1864~	3436~	*	4,9
<b>750XC</b> ◊	51984	8016287519847	220x180x340	150x150x312	80*	1864~	3436~	*	5,6
<b>750PT</b> ◊	51983	8016287519830	220x160x360	167x160x357	100*	1672~	3432~	*	5,8
<b>1100XD</b> ◊	51985	8016287519854	220x180x385	187x167x382	80*	1588~	3264~	*	7,2

\* Dati disponibili su richiesta / Data available on request

◊ Fornito in master box con 4 pezzi /

Supplied in masterbox with 4 pcs

~ Floor loaded / sfuso

• Europallet

# Idropultrici High Pressure Washers

<b>Applicazioni</b> Applications	<b>cancellate</b> fencing	<b>panchine</b> benches	<b>giardino</b> garden	<b>biciclette</b> bicycles	<b>moto</b> motorcycle	<b>auto cars</b>	<b>camper</b> recreational vehicles RV's, campers	<b>barche</b> boats	<b>pavimenti</b> flooring, paving stones	<b>scale stairs</b>	<b>piscine</b> pools
<b>Tecniche</b> Technical	<b>pressione massima</b> max pressure	<b>portata massima</b> max flow rate	<b>potenza assorbita</b> absorbed power	<b>peso netto</b> net weight	<b>motore universale</b> universal engine	<b>motore induzione</b> induction engine	<b>motore benzina</b> gasoline engine	<b>pompa a piattello</b> wobble plate pump	<b>pompa a bielle</b> rod-crank pump	<b>testa in ottone</b> brass head	<b>testa in alluminio</b> aluminum head
<b>Funzioni</b> Functions	<b>prestazioni lavaggio</b> washing performance power	<b>risparmio tempo</b> time savings	<b>altezza raggiungibile</b> reachable height	<b>sistema doppia pompa</b> double pump system	<b>sistema doppia velocità</b> double speed system	<b>sistema doppia funzione</b> double function system	<b>sistema doppia potenza</b> double power system	<b>sistema doppia applicazione</b> double pro appliance			

# Aspiratori Vacuums

<b>Applicazioni</b> Applications	<b>liquidi</b> fluids	<b>grandi volumi</b> big volumes	<b>interni</b> houses	<b>cantine</b> cellars	<b>soffitte</b> lofts	<b>autorimesse</b> garages	<b>balconi</b> balcony	<b>cucce</b> dog house, kennels	<b>piccoli cantieri</b> little work sites	<b>veicoli</b> cars	<b>poltrone divani</b> armchairs, couches
<b>Tecniche</b> Technical	<b>potenza assorbita</b> absorbed power	<b>peso netto</b> net weight	<b>n° motori</b> engines n°	<b>stadi motore</b> engine stages	<b>depressione</b> vacuum pressure	<b>aria aspirata</b> air flow rate	<b>rumorosità</b> loudness	<b>capacità fusto</b> capacity	<b>diametro accessori</b> accessory diameter		
<b>Funzioni</b> Functions	<b>aspirazione liquidi</b> liquid suction	<b>aspirazione polveri</b> dust suction	<b>funzione soffiante</b> blow function	<b>aspirazione cenere</b> ash suction	<b>presa elettro-utensile</b> power tool socket suction						

# Pompe Water Pumps

<b>Applicazioni</b> Applications	<b>irrigazione manuale</b> manual irrigation	<b>irrigazione automatica</b> automatic irrigation	<b>acque per i servizi</b> water supply	<b>allagamenti domestici</b> house flooded	<b>pozzetti</b> wells	<b>piscine</b> swimming pools	<b>cantieri</b> construction sites	<b>stagni/laghetti</b> ponds	<b>allagamenti</b> floodings		
<b>Tecniche</b> Technical	<b>pressione massima/prevalenza</b> max pressure/height	<b>portata massima</b> max flow	<b>dimensioni di montaggio</b> fitting dimensions	<b>ON/OFF automatico</b> automatic ON/OFF	<b>sistema di scarico</b> drain system	<b>facile riempimento</b> easy fill	<b>impugnatura ergonomica</b> handle	<b>montaggio da tavolo</b> table mounting	<b>serbatoio</b> tank	<b>ON/OFF automatico</b> automatic ON/OFF	<b>acqua residua</b> residual water
<b>Funzioni</b> Functions	<b>adatto ad acque pulite</b> suitable for clean water	<b>adatto ad acque sporche</b> suitable for dirty water									

## Performance

## Generiche Generic



OLIGHTPRO

HEAVYPRO



plug&play



novità new



trade selection



2in1  
Washer  
Sprayer



**utensili**  
tools

**casa**  
house

**muri**  
walls

**tetti**  
roofs

**disinfestazione zanzare**  
pest control

**gardening**  
gardening

**igienizzazione superfici**  
sanitizing

**edilizia**  
construction

**agricoltura zootecnica**  
agriculture  
zootechny

**artigianato**  
crafts

**car wash**

**automotive**



**testa nichelata**  
nichel plated head

**temperatura massima**  
max temperature

**resistenza all'acqua**  
water resistance

**giunto elastico**  
flex coupling

**sistema doppia pompa**  
double pump system

**sistema doppia velocità**  
double speed system

**sistema doppia funzione**  
double function system

**acqua fredda**  
cold water

**acqua calda**  
hot water

**regolatore pressione**  
Pressure adjustment

**TSS®**  
Total Stop SYSTEM

**TST®**  
Total Stop SYSTEM TIMED

**SPF**  
Self Priming FUNCTION



**spazi ristretti**  
limited spaces

**stufe**  
heaters

**camini**  
fireplaces

**griglie**  
grills

**edilizia**  
construction

**agricoltura zootecnica**  
agriculture  
zootechny

**artigianato**  
crafts

**car wash**

**automotive**



**dimensione massima particolato**  
max grain size

**altezza variabile**  
variable height

**corpo in acciaio inossidabile**  
stainless steel body

**testata pompa in acciaio inossidabile**  
stainless steel pump head

**portata massima**  
max flow rate

**potenza assorbita**  
absorbed power

**peso netto**  
net weight

**temperatura massima**  
max temperature

**resistenza all'acqua**  
water resistance

### Logistiche *Logistics*



**euro pallet**  
euro pallet

**full track**  
full truck

**container**

**container**

**dimensioni packaging**  
dimension packaging

**dimensioni macchina**  
dimension machine

**peso lordo**  
gross weight



**BLUE<sup>®</sup>  
CLEAN**

### **Annovi Reverberi spa**

Via Martin L. King 3  
41122 Modena (Italy)  
Tel +39 059 414 411  
info@arblueclean.it  
www.arblueclean.it

---

### **AR North America Inc.**

140 - 81st Avenue Northeast  
Fridley, MN USA 55432  
Ph. +1 763 398 2008  
Fax +1 763 398 2009  
info@arnorthamerica.com  
www.arnorthamerica.com

---

### **AR China Distribution Co., Ltd**

2nd Floor, Building 1, No. 651 Jiangting Rd.  
Jinhui Town, Fengxian District, Shanghai  
201404 China  
Ph. +86 21 54846800  
Fax +86 21 54846800 ext 815  
info@ar-china.cn  
www.ar-china.cn

© 2024 Annovi Reverberi

Cod. 90725 - BF - REF\_900000348